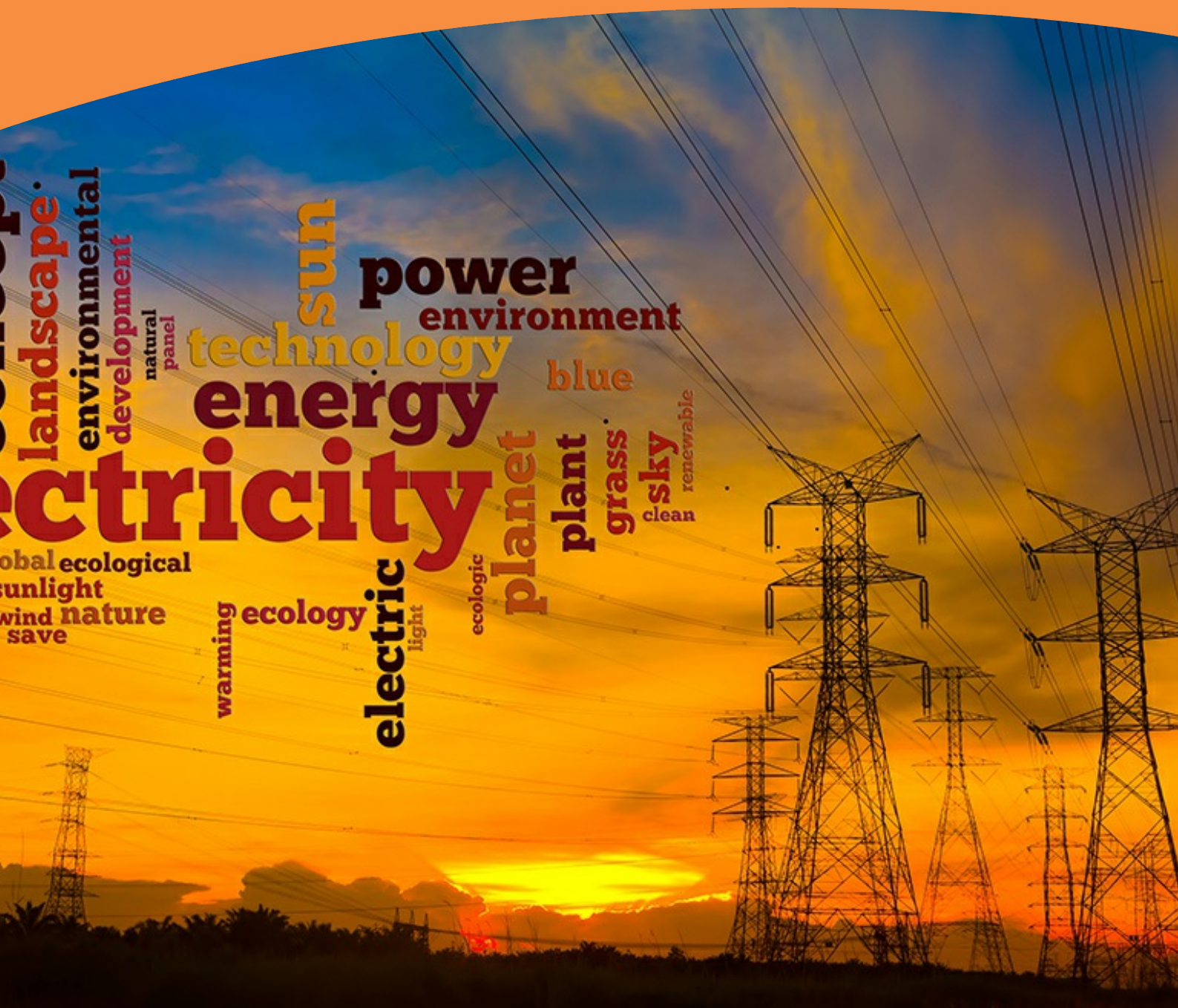


# Essential Electrodynamics

Raymond John Protheroe



Raymond John Protheroe

# Essential Electrodynamics

---

Essential Electrodynamics

1<sup>st</sup> edition

© 2015 Raymond John Protheroe & [bookboon.com](http://bookboon.com)

ISBN 978-87-403-0448-0

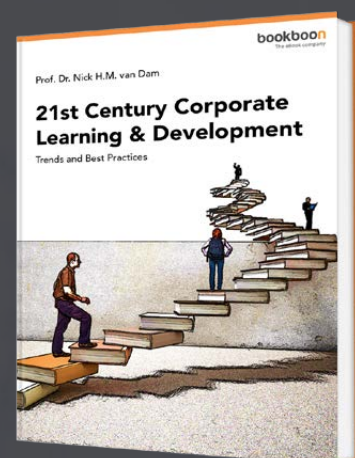
# Contents

	<b>Preface</b>	<b>8</b>
<b>1</b>	<b>Electrodynamics and conservation laws</b>	<b>10</b>
1.1	Electro-motive force	11
1.2	Maxwell's equations	20
1.3	Conservation of energy	23
1.4	Conservation of momentum	25
<b>2</b>	<b>Electromagnetic waves in empty space and linear dielectrics</b>	<b>33</b>
2.1	The wave equation and its monochromatic plane wave solutions	33
2.2	Transmission lines	38
2.3	EM waves in vacuum and linear media	44
2.4	Coherence of EM waves	50

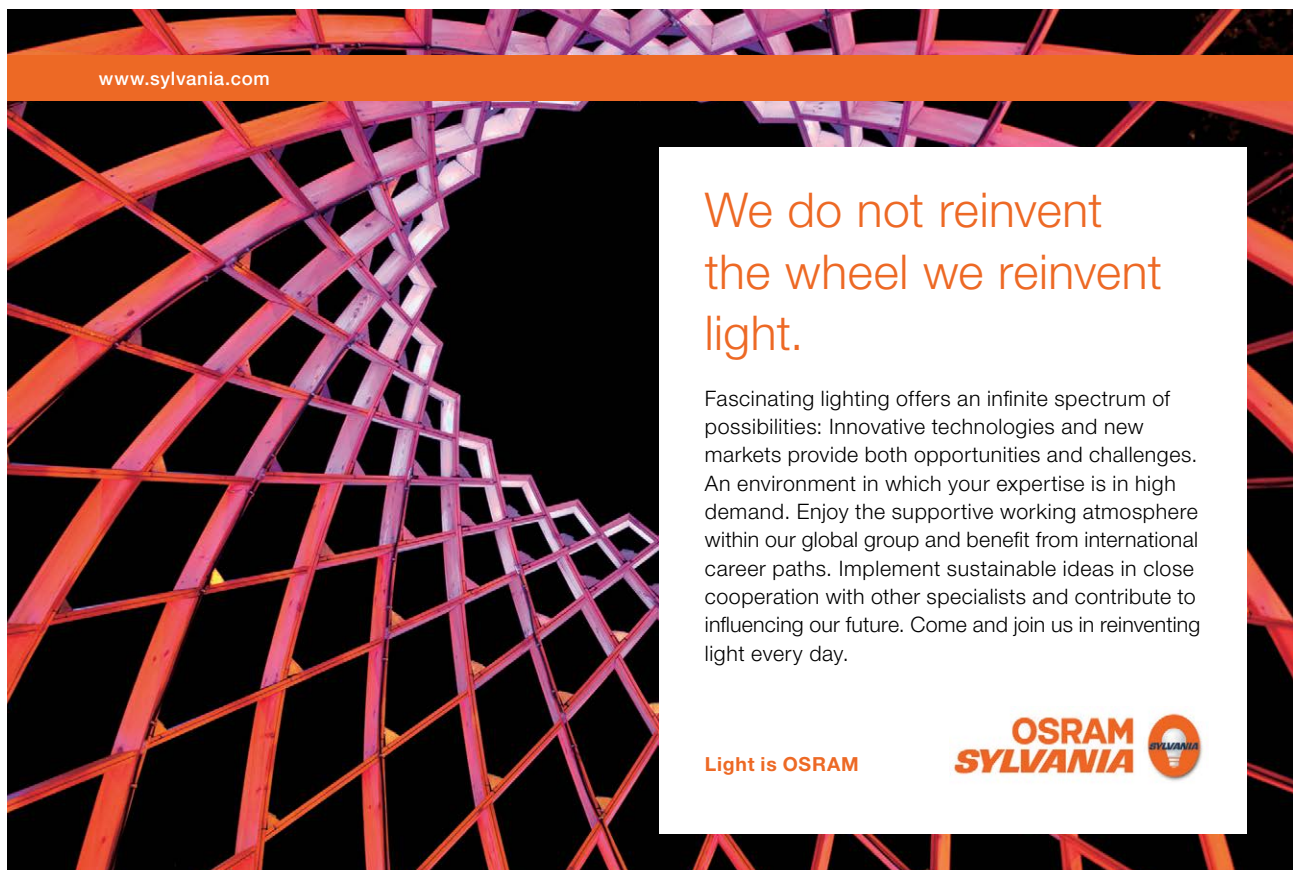
## Free eBook on Learning & Development

By the Chief Learning Officer of McKinsey

[Download Now](#)



2.5	Polarisation of EM waves	54
2.6	Reflection and transmission of EM waves at an interface between linear media	58
2.7	Fresnel equations	61
<b>3</b>	<b>Electromagnetic waves in dispersive media</b>	<b>82</b>
3.1	Dispersion and absorption	83
3.2	Dispersion	89
3.3	Refractive index of a conductor	94
3.4	Wave propagation in dilute plasmas	97
<b>4</b>	<b>Waveguides</b>	<b>114</b>
4.1	Waves in rectangular waveguides	116
4.2	Waveguide modes	119
4.3	Dispersion relation, phase and group velocities	124
4.4	The EM field and power transmitted for $TE_{10}$ mode	125




www.sylvania.com

**We do not reinvent  
the wheel we reinvent  
light.**

Fascinating lighting offers an infinite spectrum of possibilities: Innovative technologies and new markets provide both opportunities and challenges. An environment in which your expertise is in high demand. Enjoy the supportive working atmosphere within our global group and benefit from international career paths. Implement sustainable ideas in close cooperation with other specialists and contribute to influencing our future. Come and join us in reinventing light every day.

Light is OSRAM

**OSRAM  
SYLVANIA** 

<b>5</b>	<b>Radiation and scattering</b>	<b>131</b>
5.1	Larmor's formula	132
5.2	Electric dipole radiation	136
5.3	Scattering of EM radiation	140
5.4	Formal treatment of radiation by charges and currents	143
5.5	Antenna theory and multipole expansion in the far zone	146
5.6	Radiation from quadrupole antennas	151
5.7	Radiation from long antennas	152
	<b>Bibliography</b>	<b>164</b>
	<b>Appendices</b>	<b>166</b>
A	SI units and dimensions	166
B	Derivation of the Maxwell stress tensor	167
C	Time-derivative, divergence and curl of the fields of a monochromatic EM plane wave	168



Discover the truth at [www.deloitte.ca/careers](http://www.deloitte.ca/careers)

**Deloitte.**

© Deloitte & Touche LLP and affiliated entities.



Click on the ad to read more

D	EM field of a rectangular cross-section waveguide	169
E	Summary of vector calculus identities	171
	<b>Index</b>	<b>176</b>

SIMPLY CLEVER

ŠKODA



We will turn your CV into an opportunity of a lifetime



Do you like cars? Would you like to be a part of a successful brand? We will appreciate and reward both your enthusiasm and talent. Send us your CV. You will be surprised where it can take you.

Send us your CV on [www.employerforlife.com](http://www.employerforlife.com)



Click on the ad to read more

## Preface

“Essential Electrodynamics” and my previous book “Essential Electromagnetism” (also published by Ventus Publishing ApS) are intended to be resources for students taking electromagnetism courses while pursuing undergraduate studies in physics and engineering. Due to limited space available in this series, it is not possible to go into the material in great depth, so I have attempted to encapsulate what I consider to be the essentials. This book does not aim to replace existing textbooks on these topics of which there are many excellent examples, several of which are listed in the bibliography. Nevertheless, if appropriately supplemented, this book and my other book “Essential Electromagnetism” could together serve as a textbook for 2nd and 3rd year electromagnetism courses at Australian and British universities, or for junior/senior level electromagnetism courses at American universities/colleges.

The book assumes a working knowledge of partial differential equations, vectors and vector calculus as would normally be acquired in mathematics courses taken by physics and engineering students. It also assumes knowledge of electromagnetism at the level of “Essential Electromagnetism”, which also contains very brief introductions to vectors, vector calculus and index notation. Some of the mathematical derivations have been relegated to the appendices, and some of those are carried out using index notation, but elsewhere in the book manipulation of equations involving vector differential calculus is done using standard vector calculus identities given in the appendices.

“Essential Electrodynamics” starts with the electromotive force and Faraday’s law, the displacement current, Maxwell’s equations and conservation laws. It then discusses the wave equation, electromagnetic waves on lossless transmission lines, in empty space, and in linear dielectrics (including reflection and transmission at an interface). This is followed by electromagnetic waves in dispersive media including dielectrics, conductors and diffuse plasmas, as well as in waveguides. The book ends with radiation and scattering, using first an heuristic approach to derive Larmor’s formula, and then apply it to simple problems before taking up a more formal approach using the retarded potentials in the far zone to discuss antenna radiation.

Each chapter is followed by several exercise problems, and solutions to these problems are published separately by Ventus as “Essential Electrodynamics - Solutions”. I suggest you attempt these exercises before looking at the solutions.

I hope you find this book useful. If you find typos or errors I would appreciate you letting me know so that I can fix them in the next edition. Suggestions for improvement are also welcome



– please email them to me at [protheroe.essentialphysics@gmail.com](mailto:protheroe.essentialphysics@gmail.com).

I am grateful to thank Professors Anita Reimer and Todor Stanev for kindly reading a draft of the manuscript. However, all errors are entirely due to me. This book was mainly written in the evenings and I would like to thank my family for their support and forbearance.

This book is dedicated to the memory of my parents, who nurtured my interest in science.

Raymond John Protheroe,  
School of Chemistry and Physics, The University of Adelaide, Australia

Adelaide, May 2015

# 1 Electrodynamics and conservation laws

## Learning objectives

- To learn that a non-conservative electric field is present inside a source of an electro-motive force (emf) such as a battery or an electric generator, and that the total electric field in general has both conservative (electrostatic)  $\mathbf{E}_{\text{ES}}$  and non-conservative (electro-motive)  $\mathbf{E}_{\text{EM}}$  parts, such that the emf is

$$\mathcal{E} = \int_{\text{inside source}} \mathbf{E}_{\text{EM}} \cdot d\mathbf{r} = \oint_{\text{via source}} \mathbf{E}_{\text{EM}} \cdot d\mathbf{r} = \oint_{\text{via source}} (\mathbf{E}_{\text{EM}} + \mathbf{E}_{\text{ES}}) \cdot d\mathbf{r}.$$

- To understand that a changing magnetic field produces a non-conservative electric field such that the emf around circuit  $\Gamma$  is minus the rate of change of magnetic flux through surface  $S$  bounded by the circuit,

$$\oint_{\Gamma} \mathbf{E} \cdot d\mathbf{r} = -\frac{d}{dt} \int_S \mathbf{B} \cdot d\mathbf{S} = -\frac{d}{dt} \oint_{\Gamma} \mathbf{A} \cdot d\mathbf{r}.$$

- To understand the concept of inductance and be able to calculate the mutual and self inductance in simple problems.
- To know that the change in energy density stored in a magnetic field is in general

$$du = \mathbf{H} \cdot d\mathbf{B},$$

and for linear materials the energy density is

$$u = \frac{1}{2} \mathbf{H} \cdot \mathbf{B} = \frac{1}{2} \mu H^2 = \frac{1}{2\mu} B^2.$$

- To know that by introducing the concept of the displacement current, and modifying Ampere's Law, Maxwell was able to unify electricity and magnetism in the form of his four equations which give the divergence and curl of the electric and magnetic fields.
- To know and understand the various terms in Poynting's theorem which expresses conservation of energy in electrodynamics, and that the rate of energy flow is described by the Poynting vector  $\mathbf{S} = \mathbf{E} \times \mathbf{H}$ .

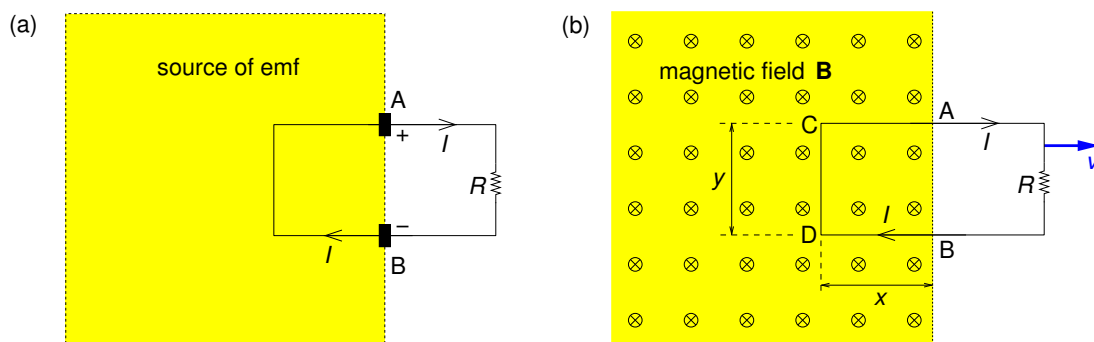
- To know that the electromagnetic momentum density is  $\mathbf{g} = \epsilon_0 \mathbf{E} \times \mathbf{B} = \mu_0 \epsilon_0 \mathbf{E} \times \mathbf{H} = \mathbf{S}/c^2$ .

## 1.1 Electro-motive force

The *electro-motive force* (abbreviation emf, symbol  $\mathcal{E}$ , unit  $V$ ) is what drives a current around a circuit. Examples of sources of emf include batteries, piezoelectric crystals, solar cells and electrical generators (alternators and dynamos). In electrical generators an engine fuelled, for example by coal, oil or nuclear fission, or a water turbine in a hydroelectric plant or a wind turbine in a wind farm, moves conductors through a magnetic field to produce electricity.

The purpose of a source of emf is to maintain a potential difference across its terminals. Within a source of emf there is a non-conservative “electro-motive” force  $\mathbf{F}_{\text{EM}}$  acting on positive charges and pushing them *towards* the positive terminal “A”, and on negative charges pushing them towards the negative terminal “B” (see Fig. 1.1a). Integrating the electro-motive force per unit charge  $\mathbf{E}_{\text{EM}} = \mathbf{F}_{\text{EM}}/q$  from the negative terminal through the source of emf to the positive terminal gives the emf,

$$\mathcal{E} = \int_{\text{inside source}} \mathbf{E}_{\text{EM}} \cdot d\mathbf{r}. \quad (1.1)$$



**Figure 1.1:** (a) Source of emf: inside the source the electro-motive “force” pushes positive charge towards the positive terminal; outside the source the electro-motive “force” is zero and the electrostatic force pushes positive charge towards the negative terminal. (b) Motional emf: the circuit is pulled to the right at constant velocity  $\mathbf{v}$  through a uniform magnetic field  $\mathbf{B}$  (pointing into the page) which causes current  $I$  to flow.

The electro-motive force exists only inside the source of emf. Within the source it is in the opposite direction to the (conservative) electrostatic force  $q\mathbf{E}_{\text{ES}}$  which pushes positive charges *away from* the positive terminal, and the electro-motive and the electrostatic forces cancel each

other out. Thus, if we integrate the vector sum of the two forces per unit charge,  $\mathbf{E}_{\text{total}} = \mathbf{E}_{\text{EM}} + \mathbf{E}_{\text{ES}}$  around a closed loop from the negative terminal through the source of emf to the positive terminal then outside the source back to the negative terminal we also get the emf because  $\mathbf{E}_{\text{EM}} = 0$  outside the source and  $\oint \mathbf{E}_{\text{ES}} \cdot d\mathbf{r} = 0$ , and so

$$\mathcal{E} = \oint_{\text{via source}} \mathbf{E}_{\text{total}} \cdot d\mathbf{r} \quad (1.2)$$

From now I shall represent  $\mathbf{E}_{\text{total}}$  simply by  $\mathbf{E}$  and remember it is in general the vector sum of the electrostatic field and the non-conservative electric field associated with a source of emf.

### 1.1.1 Motional emf

Consider a wire moving at velocity  $\mathbf{v}$  through a magnetic field  $\mathbf{B}$  as shown in Fig. 1.1(b). A charge  $q$  in the wire experiences a force  $q\mathbf{v} \times \mathbf{B}$  in the direction from D to C. Integrating the magnetic force per unit charge  $\mathbf{v} \times \mathbf{B}$  around the circuit, we obtain the *motional emf*



**e-learning for kids**

- The number 1 MOOC for Primary Education
- Free Digital Learning for Children 5-12
- 15 Million Children Reached

**About e-Learning for Kids** Established in 2004, e-Learning for Kids is a global nonprofit foundation dedicated to fun and free learning on the Internet for children ages 5 - 12 with courses in math, science, language arts, computers, health and environmental skills. Since 2005, more than 15 million children in over 190 countries have benefitted from eLessons provided by EFK! An all-volunteer staff consists of education and e-learning experts and business professionals from around the world committed to making difference. eLearning for Kids is actively seeking funding, volunteers, sponsors and courseware developers; get involved! For more information, please visit [www.e-learningforkids.org](http://www.e-learningforkids.org).

$$\mathcal{E} = \oint \mathbf{v} \times \mathbf{B} \cdot d\mathbf{r} = vBy, \quad (1.3)$$

which is entirely due to section D–C as other parts of the wire either have  $\mathbf{v} \times \mathbf{B} \cdot d\mathbf{r} = 0$  (B–D and C–A) or are outside the magnetic field region. The emf drives a current through the resistor which dissipates as heat at a rate  $\mathcal{E}^2/R$  equal to the work done by someone pulling the wire through the magnetic field (assuming 100% efficiency). This is the basic principle behind electrical generators.

### 1.1.2 Electromagnetic induction and Faraday's law

English physicist and chemist Michael Faraday (1791–1867) discovered that the emf produced was proportional to the rate of change of magnetic flux through the circuit. For the circuit shown in Fig. 1.1(b) the magnetic flux through the circuit is

$$\Phi_B = \int_S \mathbf{B} \cdot d\mathbf{S} = Byx. \quad (1.4)$$

As the loop moves, the flux decreases:

$$\frac{d\Phi_B}{dt} = By \frac{dx}{dt} = -Byv. \quad (1.5)$$

Apart from the sign (because  $x$  is decreasing) this is just the emf we found before,

$$\therefore \mathcal{E} = -\frac{d\Phi_B}{dt}. \quad (1.6)$$

Faraday conducted experiments of the type shown in Fig. 1.1(b), as well as experiments keeping the circuit fixed and moving the magnet instead of the circuit, and experiments in which the circuit was fixed but the strength of the magnetic field was varied. In all cases a current flowed, and the emf was described by *Faraday's law* (Eq. 1.6) which is sometimes called the *universal flux law*, i.e. a changing magnetic flux induces an emf proportional to its rate of change. The minus sign is there because induced currents produce a magnetic field which tends to oppose the change in magnetic flux (*Lenz' law*, after Russian physicist Heinrich Friedrich Emil Lenz 1804–1865) – nature resists change!

It remained a puzzle why this same formula (Eq. 1.6) applied to the three quite different types of experiment carried out by Faraday, until Einstein developed his special theory of relativity.

We can write Faraday's law as

$$\oint_{\Gamma} \mathbf{E} \cdot d\mathbf{r} = -\frac{d}{dt} \int_S \mathbf{B} \cdot d\mathbf{S} = -\int_S \frac{\partial \mathbf{B}}{\partial t} \cdot d\mathbf{S} \quad (1.7)$$

where loop  $\Gamma$  bounds surface  $S$ . But, using Stokes' theorem

$$\oint_{\Gamma} \mathbf{E} \cdot d\mathbf{r} = \int_S (\nabla \times \mathbf{E}) \cdot d\mathbf{S}, \quad (1.8)$$

we obtain Faraday's law in differential form

$$\nabla \times \mathbf{E} = -\frac{\partial \mathbf{B}}{\partial t}. \quad (1.9)$$

We see that a changing magnetic field produces an *induced electric field* which has  $\nabla \times \mathbf{E}$  as above and  $\nabla \cdot \mathbf{E} = 0$ . This is in contrast to the electrostatic field for which  $\nabla \times \mathbf{E} = 0$  and  $\nabla \cdot \mathbf{E} = \rho/\epsilon_0$  — note that in the static case, i.e.  $\partial \mathbf{B}/\partial t = 0$ , we have  $\nabla \times \mathbf{E} = 0$  as expected.

### 1.1.3 Faraday's law in terms of the vector potential

The magnetic flux through a surface  $S$  bounded by closed curve  $\Gamma$  is

$$\Phi_B \equiv \int_S \mathbf{B}(\mathbf{r}) \cdot d\mathbf{S} = \int_S \nabla \times \mathbf{A}(\mathbf{r}) \cdot d\mathbf{S} = \oint_{\Gamma} \mathbf{A}(\mathbf{r}) \cdot d\mathbf{r},$$

where we have used Stokes' theorem to get the final result above. Hence,

$$\oint_{\Gamma} \mathbf{E} \cdot d\mathbf{r} = -\frac{d}{dt} \int_S \mathbf{B} \cdot d\mathbf{S} = -\frac{d}{dt} \oint_{\Gamma} \mathbf{A} \cdot d\mathbf{r} = -\oint_{\Gamma} \frac{\partial \mathbf{A}}{\partial t} \cdot d\mathbf{r} \quad (1.10)$$

and we can write Faraday's law in terms of the vector potential

$$\mathbf{E} = -\frac{\partial \mathbf{A}}{\partial t}. \quad (1.11)$$

Hence, the total electric field, including both the electrostatic part and the electric field due to a changing magnetic field, is

$$\mathbf{E} = -\nabla V - \frac{\partial \mathbf{A}}{\partial t}. \quad (1.12)$$

#### 1.1.4 Mutual inductance

Since electric currents produce magnetic fields, time-varying currents produce time-varying magnetic fields. Hence, a time-varying current in a circuit will produce a time-varying magnetic flux through a nearby circuit loop causing an emf in that loop. The mutual inductance was introduced in Chapter 5 of “Essential Electromagnetism” where it was defined as follows. Suppose you have two coils of wire at rest and you run current  $I_1$  around Coil 1 the magnetic flux due to Coil 1 through Coil 2 divided by  $I_1$  is the *mutual inductance*  $M$  of the two coils. For the case of time-varying currents, from Faraday’s law, the emf in Coil 2 due to a changing current in Coil 1, and the emf in Coil 1 due to a changing current in Coil 2 are

$$\mathcal{E}_2 = -\frac{d\Phi_{B2}}{dt} = -M \frac{dI_1}{dt}, \quad \mathcal{E}_1 = -\frac{d\Phi_{B1}}{dt} = -M \frac{dI_2}{dt}. \quad (1.13)$$

Cynthia | AXA Graduate

**AXA Global Graduate Program**

Find out more and apply

redefining / standards AXA

As an example of calculating the mutual inductance we consider a solenoid comprising  $N_1$  coils tightly wound around a cylindrical rod made of a material with magnetic permeability  $\mu$ , and a second solenoid comprising  $N_2$  coils loosely wound around the first solenoid as shown in Fig. 1.2(a). It is easier to calculate the flux due to the tightly-wound solenoid through the loosely-wound solenoid, than the flux due to the loosely-wound solenoid through the tightly-wound solenoid. The magnitude of the magnetic field inside the tightly-wound solenoid is approximately

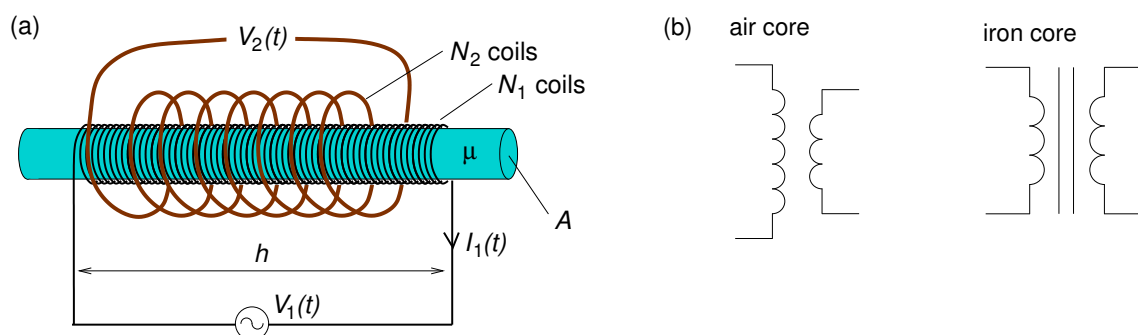
$$B_1(t) = \mu \frac{N_1}{h} I_1(t), \quad (1.14)$$

and so the magnetic flux threading the  $N_2$  coils of the loosely-wound solenoid is

$$\Phi_{B_2}(t) = N_2 A \mu \frac{N_1}{h} I_1(t) \quad (1.15)$$

giving

$$M = \mu \frac{N_1 N_2 A}{h}. \quad (1.16)$$



**Figure 1.2:** (a) Example of mutual inductance of a loosely-wound solenoid around a tightly-wound solenoid. (b) Circuit symbols for transformers.

A circuit such as that shown in Fig. 1.2(a) could serve as a *transformer* in AC circuits as the output voltage would differ from the input voltage. Generally if the two coils share the same magnetic flux *per individual coil element or “turn”* the ratio of the voltage across the secondary coils ( $N_s$  turns) to that across the primary coils ( $N_p$  turns) is

$$\frac{V_s}{V_p} = \frac{N_s}{N_p}. \quad (1.17)$$

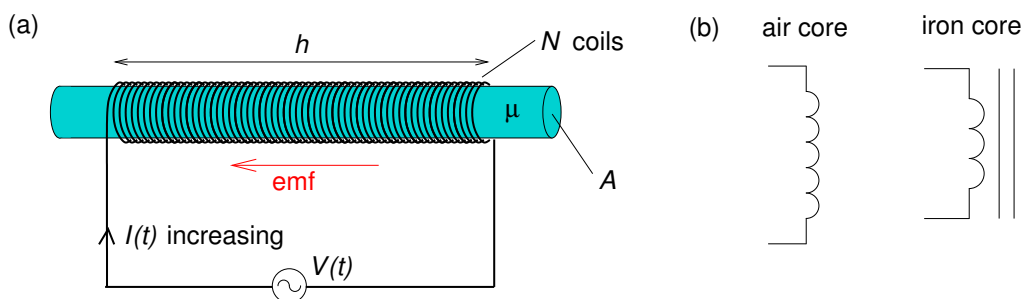
In the example above the tightly-wound solenoid is the primary (p) and the loosely wound one is



the secondary (s). To ensure the two coils share the same magnetic flux per turn, transformers may have a core made of a high permeability material, i.e. one having  $\mu \gg \mu_0$  such as soft iron. Circuit symbols for air-core and iron-core transformers are shown in Fig. 1.2(b). The core would often be in the shape of a torus to minimise magnetic flux leakage.

### 1.1.5 Self inductance

A changing current not only induces an emf in a nearby circuit, it also induces an emf in the source circuit. As an example, we consider a variable voltage source  $V(t)$  connected to a solenoid wound around a cylindrical rod made of a material with permeability  $\mu$ , as in Fig. 1.3(a).



**Figure 1.3:** (a) Solenoid connected to a variable voltage source; arrow shows direction of the back-emf induced due to an increasing current. (b)—Circuit symbols for an inductor.

The magnetic flux through the solenoid is proportional to the current  $\Phi_B = LI$  where  $L$  is the *self-inductance* (or simply *inductance*) of the loop which depends only on its geometry. In the case of the solenoid shown, with current  $I(t)$ , the magnitude of magnetic field inside the solenoid is approximately

$$B(t) = \mu \frac{N}{h} I(t), \quad (1.18)$$

and so the magnetic flux threading the  $N$  coils of the solenoid is

$$\Phi_B(t) = NA\mu \frac{N}{h} I(t) \quad (1.19)$$

giving

$$L = \mu \frac{N^2 A}{h}. \quad (1.20)$$

If the current changes, the emf around the loop is

$$\mathcal{E} = -\frac{d\Phi_B}{dt} = -L\frac{dI}{dt}. \quad (1.21)$$

Thus, changing the current through a circuit induces a “back emf” which tends to oppose the change in magnetic flux (Lenz’ law) as shown in Fig. 1.3(a). Circuit elements designed to have significant self-inductance are called *inductors* and would usually have a core made of a magnetically soft material, e.g. soft iron and, as with transformers, the core would often be in the shape of a torus to minimise magnetic flux leakage. Circuit symbols are shown in Fig. 1.3(b).

### 1.1.6 Energy stored in magnetic fields

A certain amount of *energy* is needed to start a current in a circuit – work is done against the back emf to get the current going and set up the magnetic field. The work done to move unit charge against the back emf in one trip around the circuit is  $\mathcal{E}$ . The amount of charge per unit time passing down the wire is  $I$ , so the work done per unit time is

I joined MITAS because  
I wanted **real responsibility**

The Graduate Programme  
for Engineers and Geoscientists  
[www.discovermitas.com](http://www.discovermitas.com)



**Month 16**  
I was a construction  
supervisor in  
the North Sea  
advising and  
helping foremen  
solve problems

Real work  
International opportunities  
Three work placements





$$\frac{dW}{dt} = -\mathcal{E}I = LI\frac{dI}{dt}. \quad (1.22)$$

The total work done in establishing the magnetic field is

$$W = L \int IdI = \frac{1}{2}LI^2. \quad (1.23)$$

We can show that the work  $W$  done in establishing the magnetic field is stored as magnetic field energy  $U$ . In establishing the field, the power source does work at rate  $dW/dt \equiv dU/dt = -I\mathcal{E} = -\int \mathbf{J} \cdot \mathbf{E}$ , for current density  $\mathbf{J}(\mathbf{r}) = \nabla \times \mathbf{H}(\mathbf{r})$  and induced electric field  $\mathbf{E}(\mathbf{r}) = -\partial\mathbf{A}/\partial t$ . Then

$$\frac{dU}{dt} = \int (\nabla \times \mathbf{H}) \cdot \left( \frac{\partial \mathbf{A}}{\partial t} \right) d^3r, \quad (1.24)$$

$$= \int \nabla \cdot \left( \mathbf{H} \times \frac{\partial \mathbf{A}}{\partial t} \right) d^3r + \int \mathbf{H} \cdot \left( \nabla \times \frac{\partial \mathbf{A}}{\partial t} \right) d^3r. \quad (1.25)$$

$$= \oint \left( \mathbf{H} \times \frac{\partial \mathbf{A}}{\partial t} \right) \cdot d\mathbf{S} + \int \mathbf{H} \cdot \left( \frac{\partial \mathbf{B}}{\partial t} \right) d^3r, \quad (1.26)$$

$$\therefore \frac{dU}{dt} = \int \mathbf{H} \cdot \left( \frac{\partial \mathbf{B}}{\partial t} \right) d^3r, \quad (1.27)$$

where the product rule identity for  $\nabla \cdot (\mathbf{a} \times \mathbf{b})$  (Eq. E.6) is used to get Eq. 1.25 and Gauss' theorem to get Eq. 1.26. As the volume integrals are over all space, the surface integral is for the surface at  $r = \infty$ , and with the integrand dropping faster than  $dS \sim r^{-2}$  we arrive at Eq. 1.27. This tells us that the change in the magnetic energy density due to a small change  $d\mathbf{B}(\mathbf{r})$  in the magnetic field is

$$d[u(\mathbf{r})] = \mathbf{H}(\mathbf{r}) \cdot d\mathbf{B}(\mathbf{r}). \quad (1.28)$$

For linear materials,

$$d[u(\mathbf{r})] = \mathbf{H}(\mathbf{r}) \cdot d[\mu\mathbf{H}(\mathbf{r})] = \frac{1}{2}d[\mathbf{H}(\mathbf{r}) \cdot \mu\mathbf{H}(\mathbf{r})] = \frac{1}{2}d[\mathbf{H}(\mathbf{r}) \cdot \mathbf{B}(\mathbf{r})]. \quad (1.29)$$

Hence, the magnetic energy density in linear materials is

$$u(\mathbf{r}) = \frac{1}{2}[\mathbf{H}(\mathbf{r}) \cdot \mathbf{B}(\mathbf{r})] = \frac{H(\mathbf{r})B(\mathbf{r})}{2} = \frac{\mu[H(\mathbf{r})]^2}{2} = \frac{[B(\mathbf{r})]^2}{2\mu}. \quad (1.30)$$

## 1.2 Maxwell's equations

Scottish theoretical physicist James Clerk Maxwell (1831–1879) unified electricity and magnetism into classical electrodynamics. A logical development of his equations follows. In going from electrostatics ( $\nabla \times \mathbf{E} = 0$ ) to electrodynamics,  $\mathbf{E}$  is no longer conservative, and  $\nabla \times \mathbf{E}$  is given instead by Faraday's law. In a similar way, Ampere's law needs modifying. To show this, consider the second-derivative  $\nabla \cdot (\nabla \times \mathbf{a})$  which must be zero for any vector field  $\mathbf{a}(\mathbf{r})$ . Substitution shows that  $\mathbf{E}(\mathbf{r})$  satisfies this condition in electrodynamics, but that  $\mathbf{B}(\mathbf{r})$  does not unless Ampere's law is modified.

The divergence of Ampere's law

$$\nabla \cdot (\nabla \times \mathbf{B}) = \nabla \cdot (\mu_0 \mathbf{J}) \quad (1.31)$$

is non-zero in electrodynamics because charge conservation requires that

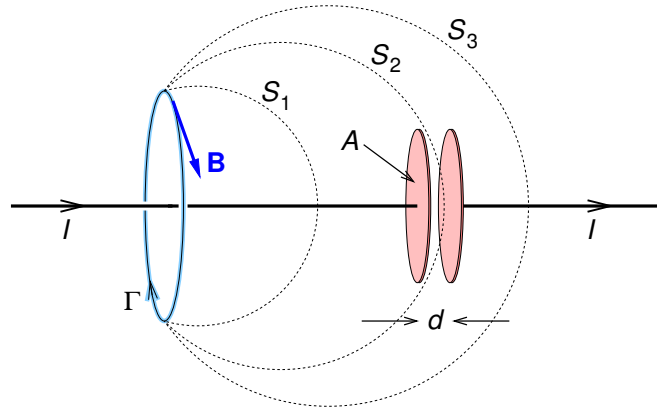
$$\nabla \cdot \mathbf{J} = -\frac{\partial \rho}{\partial t}. \quad (1.32)$$

Eq. 1.32 is the *continuity equation*.

We can gain further insight to the problem by considering the charging a capacitor as in Fig. 1.4. Ampere's law in integral form

$$\oint_{\Gamma} \mathbf{B} \cdot d\mathbf{r} = \mu_0 \int_S \mathbf{J} \cdot d\mathbf{S} \quad (1.33)$$

should apply for any surface  $S$  bounded by closed loop  $\Gamma$ , such as surfaces  $S_1$ ,  $S_2$  or  $S_3$ . The right hand side is  $\mu_0 I$  for surfaces  $S_1$  and  $S_3$ , but is zero for surface  $S_2$  which goes between the capacitor plates.



**Figure 1.4:** The problem with Ampere's law as illustrated by the charging of a parallel plate capacitor.

### 1.2.1 Displacement current

We can use Gauss' law to replace  $\rho = \epsilon_0 \nabla \cdot \mathbf{E}$  in the continuity equation (Eq. 1.32) to get

$$\nabla \cdot \mathbf{J} + \frac{\partial(\epsilon_0 \nabla \cdot \mathbf{E})}{\partial t} = 0. \tag{1.34}$$



# 93%

OF MIM STUDENTS ARE  
WORKING IN THEIR SECTOR 3 MONTHS  
FOLLOWING GRADUATION

---

MASTER IN MANAGEMENT

---

- STUDY IN THE CENTER OF MADRID AND TAKE ADVANTAGE OF THE UNIQUE OPPORTUNITIES THAT THE CAPITAL OF SPAIN OFFERS
- PROPEL YOUR EDUCATION BY EARNING A DOUBLE DEGREE THAT BEST SUITS YOUR PROFESSIONAL GOALS
- STUDY A SEMESTER ABROAD AND BECOME A GLOBAL CITIZEN WITH THE BEYOND BORDERS EXPERIENCE

Length: 10 MONTHS  
Av. Experience: 1 YEAR  
Language: ENGLISH / SPANISH  
Format: FULL-TIME  
Intakes: SEPT / FEB

---

**5 SPECIALIZATIONS**  
PERSONALIZE YOUR PROGRAM

**#10 WORLDWIDE**  
MASTER IN MANAGEMENT  
FINANCIAL TIMES

**55 NATIONALITIES**  
IN CLASS

www.ie.edu/master-management
| mim.admissions@ie.edu
| 
Follow us on IE MIM Experience



$$\therefore \nabla \cdot (\mathbf{J} + \mathbf{J}_D) = 0 \quad (1.35)$$

where

$$\mathbf{J}_D \equiv \varepsilon_0 \left( \frac{\partial \mathbf{E}}{\partial t} \right) \quad (1.36)$$

is the *displacement current density*, and has the same dimensions as the current density. Since  $\mathbf{J}_D$  is caused by a changing electric field, it will be non-zero between the capacitor plates in Fig. 1.4.

Using Eq. 1.35, Ampere's Law can then be modified to make  $\nabla \cdot (\nabla \times \mathbf{B}) = 0$ , i.e.

$$\nabla \times \mathbf{B} = \mu_0 \mathbf{J} + \mu_0 \varepsilon_0 \frac{\partial \mathbf{E}}{\partial t} \quad (1.37)$$

which is Ampere's law as modified by Maxwell. From this we may conclude that currents and displacement currents are on an equal footing in electrodynamics, and that a changing electric field induces a magnetic field.

Returning to the problem of the charging capacitor (Fig. 1.4), and assuming the electric field is uniform between the plates and zero elsewhere, Gauss' law gives

$$E = \frac{\sigma}{\varepsilon_0} = \frac{1}{\varepsilon_0} \frac{Q}{A} \quad (1.38)$$

where  $\sigma$  is the surface charge density,  $Q$  is the charge and  $A$  the plate area. Thus between the plates the displacement current is

$$|\mathbf{J}_D| = \varepsilon_0 \left| \frac{\partial \mathbf{E}}{\partial t} \right| = \frac{1}{A} \frac{dQ}{dt} = \frac{I}{A}, \quad \therefore I_D = \int_{S_2} \mathbf{J}_D \cdot d\mathbf{S} = \frac{I}{A} A = I. \quad (1.39)$$

Hence, the total displacement current  $I_D$  between the plates is identical to the current  $I$  in the wires charging the plates.

### 1.2.2 Maxwell's equations in vacuum and in matter

Maxwell modified Ampere's law in 1865 to make it apply to electrodynamics by adding the displacement current to the current. Replacing  $\varepsilon_0 \mathbf{E}$  with  $\mathbf{D}$  and  $\mathbf{B}/\mu_0$  with  $\mathbf{H}$  we obtain versions applicable to matter. The sets of four equations of electrodynamics thus modified are known as *Maxwell's equations*:

<b>Vacuum:</b>	<b>Matter:</b>	
$\nabla \cdot \mathbf{E} = \frac{\rho}{\varepsilon_0}$	$\nabla \cdot \mathbf{D} = \rho_f$	(Gauss' law)
$\nabla \cdot \mathbf{B} = 0$	$\nabla \cdot \mathbf{B} = 0$	(no magnetic charge)
$\nabla \times \mathbf{E} = -\frac{\partial \mathbf{B}}{\partial t}$	$\nabla \times \mathbf{E} = -\frac{\partial \mathbf{B}}{\partial t}$	(Faraday's law)
$\nabla \times \mathbf{B} = \mu_0 \mathbf{J} + \mu_0 \varepsilon_0 \frac{\partial \mathbf{E}}{\partial t}$	$\nabla \times \mathbf{H} = \mathbf{J}_f + \frac{\partial \mathbf{D}}{\partial t}$	(Ampere's law)

(1.40)

These four equations together with the Lorentz force law  $\mathbf{F} = q(\mathbf{E} + \mathbf{v} \times \mathbf{B})$  encapsulate classical electrodynamics.

### 1.3 Conservation of energy

In 1884 English physicist John Henry Poynting (1852–1914) published his theorem, which is an expression of the law of conservation of energy in electrodynamics. We shall obtain Poynting's theorem from Maxwell's equations by taking the dot product of  $\mathbf{E}$  with Ampère's Law and the dot product of  $\mathbf{H}$  with Faraday's Law to obtain

$$\mathbf{E} \cdot (\nabla \times \mathbf{H}) = \mathbf{E} \cdot \left( \mathbf{J} + \frac{\partial \mathbf{D}}{\partial t} \right), \quad (1.41)$$

$$\mathbf{H} \cdot (\nabla \times \mathbf{E}) = \mathbf{H} \cdot \left( -\frac{\partial \mathbf{B}}{\partial t} \right). \quad (1.42)$$

Subtracting Eq. 1.42 from Eq. 1.41 gives

$$\mathbf{E} \cdot (\nabla \times \mathbf{H}) - \mathbf{H} \cdot (\nabla \times \mathbf{E}) = \mathbf{E} \cdot \mathbf{J} + \left( \mathbf{E} \cdot \frac{\partial \mathbf{D}}{\partial t} + \mathbf{H} \cdot \frac{\partial \mathbf{B}}{\partial t} \right). \quad (1.43)$$

Then using the product rule  $\nabla \cdot (\mathbf{e} \times \mathbf{h}) = \mathbf{h} \cdot (\nabla \times \mathbf{e}) - \mathbf{e} \cdot (\nabla \times \mathbf{h})$  we obtain

$$-\nabla \cdot (\mathbf{E} \times \mathbf{H}) = \mathbf{E} \cdot \mathbf{J} + \left( \mathbf{E} \cdot \frac{\partial \mathbf{D}}{\partial t} + \mathbf{H} \cdot \frac{\partial \mathbf{B}}{\partial t} \right). \quad (1.44)$$

Taking the volume integral of both sides, and then using Gauss' theorem on the left hand side we get *Poynting's Theorem*:

$$-\oint_{\Sigma} (\mathbf{E} \times \mathbf{H}) \cdot d\boldsymbol{\Sigma} = \int_V \mathbf{E} \cdot \mathbf{J} d^3r + \int_V \left( \mathbf{E} \cdot \frac{\partial \mathbf{D}}{\partial t} + \mathbf{H} \cdot \frac{\partial \mathbf{B}}{\partial t} \right) d^3r \quad (1.45)$$

where  $d\boldsymbol{\Sigma}$  is the surface element, and surface  $\Sigma$  bounds volume  $V$ .

Take a look at the two terms on the right hand side of Eq. 1.45:

$\int_V \mathbf{E} \cdot \mathbf{J} d^3r$  — this is the power dissipated in volume  $V$  as kinetic energy (e.g. Joule heating);

$\int_V \left( \mathbf{E} \cdot \frac{\partial \mathbf{D}}{\partial t} + \mathbf{H} \cdot \frac{\partial \mathbf{B}}{\partial t} \right) d^3r$  — this is the rate of increase of field energy in volume  $V$ .

Hence  $\oint_{\Sigma} (\mathbf{E} \times \mathbf{H}) \cdot (-d\boldsymbol{\Sigma})$  must be the rate of flow of energy through area  $\Sigma$  *into* volume  $V$

"I studied English for 16 years but...  
...I finally learned to speak it in just six lessons"

Jane, Chinese architect

ENGLISH OUT THERE

Click to hear me talking before and after my unique course download



(into because of the minus sign). Thus we define the *Poynting Vector*

$$\mathbf{S} \equiv \mathbf{E} \times \mathbf{H} \quad (1.46)$$

which gives the energy flux ( $\text{W m}^{-2}$ ) carried by the electromagnetic field, and points in the direction of energy flow.

## 1.4 Conservation of momentum

One can derive the equation describing conservation of momentum from the force on a particle of charge  $q$ , as given by Lorentz force equation  $\mathbf{F} = (q\mathbf{E} + q\mathbf{v} \times \mathbf{B})$ . For the charges inside volume  $V$  this becomes

$$\frac{d\mathbf{P}_{\text{part}}}{dt} = \int_V (\rho\mathbf{E} + \mathbf{J} \times \mathbf{B}) d^3r \quad (1.47)$$

where  $\mathbf{P}_{\text{part}}$  is the total momentum of the particles inside  $V$ , and we have used  $\rho\mathbf{v} = \mathbf{J}$ . Using all four of Maxwell's equations, the integrand can be written

$$\mathbf{I} = (\varepsilon_0 \nabla \cdot \mathbf{E})\mathbf{E} + \left[ \frac{1}{\mu_0} (\nabla \times \mathbf{B}) - \varepsilon_0 \frac{\partial \mathbf{E}}{\partial t} \right] \times \mathbf{B}, \quad (1.48)$$

$$= (\varepsilon_0 \nabla \cdot \mathbf{E})\mathbf{E} + \frac{1}{\mu_0} (\nabla \times \mathbf{B}) \times \mathbf{B} - \left[ \varepsilon_0 \frac{\partial (\mathbf{E} \times \mathbf{B})}{\partial t} - \varepsilon_0 \mathbf{E} \times \frac{\partial \mathbf{B}}{\partial t} \right], \quad (1.49)$$

$$= (\varepsilon_0 \nabla \cdot \mathbf{E})\mathbf{E} + \frac{1}{\mu_0} (\nabla \times \mathbf{B}) \times \mathbf{B} - \frac{\partial (\varepsilon_0 \mathbf{E} \times \mathbf{B})}{\partial t} - \varepsilon_0 \mathbf{E} \times (\nabla \times \mathbf{E}), \quad (1.50)$$

$$= -\frac{\partial (\varepsilon_0 \mathbf{E} \times \mathbf{B})}{\partial t} + \varepsilon_0 [(\nabla \cdot \mathbf{E})\mathbf{E} - \mathbf{E} \times (\nabla \times \mathbf{E})] + \frac{1}{\mu_0} [(\nabla \cdot \mathbf{B})\mathbf{B} - \mathbf{B} \times (\nabla \times \mathbf{B})], \quad (1.51)$$

(Gauss' law and the modified Ampere's law were used in Eq. 1.48, and Faraday's law was used in Eq. 1.50, and  $\nabla \cdot \mathbf{B} = 0$  in Eq. 1.51).

Re-writing Eq. 1.47 with the terms involving time-derivatives on the left hand side

$$\begin{aligned} \frac{d}{dt} \left[ \mathbf{P}_{\text{part}} + \int_V (\varepsilon_0 \mathbf{E} \times \mathbf{B}) d^3r \right] \\ = \int_V \left\{ \varepsilon_0 [(\nabla \cdot \mathbf{E})\mathbf{E} - \mathbf{E} \times (\nabla \times \mathbf{E})] + \frac{1}{\mu_0} [(\nabla \cdot \mathbf{B})\mathbf{B} - \mathbf{B} \times (\nabla \times \mathbf{B})] \right\} d^3r \end{aligned} \quad (1.52)$$

we can identify the left hand side as the rate of change of particle and field momentum in volume  $V$ , and so the *electromagnetic field momentum density* must be

$$\mathbf{g} = \varepsilon_0 \mathbf{E} \times \mathbf{B} = \mu_0 \varepsilon_0 \mathbf{E} \times \mathbf{H} = \frac{1}{c^2} \mathbf{S}. \quad (1.53)$$

The right hand side of Eq. 1.52 must equal the rate of flow of momentum into volume  $V$ . We will see this more easily if we are able to re-write the right hand side as a flux integral with the help of Gauss' theorem, but we must first write the integrand as the divergence of some field. But, since the rate of increase of momentum density is a vector field having 3 dimensions, the quantity we must take the divergence of will have 9 dimensions. This tensor field,  $T_{ij}$ , is called the *Maxwell stress tensor*, and momentum conservation in electrodynamics is expressed by

$$\frac{d}{dt} \left[ \mathbf{P}_{\text{part}} + \int_V (\varepsilon_0 \mathbf{E} \times \mathbf{B}) d^3r \right] = \sum_i \hat{\mathbf{e}}_i \int_V \left( \sum_j \frac{\partial}{\partial x_j} T_{ij} \right) d^3r, \quad (1.54)$$

$$= \sum_i \hat{\mathbf{e}}_i \oint_S \left( \sum_j T_{ij} \hat{\mathbf{e}}_j \cdot \hat{\mathbf{n}} \right) dS, \quad (1.55)$$

where  $\hat{\mathbf{n}}$  is the outward normal unit vector at surface  $S$  which bounds volume  $V$ . In Appendix B I prove that

$$T_{ij} = \varepsilon_0 \left[ E_i E_j + c^2 B_i B_j - \frac{1}{2} \delta_{ij} (\mathbf{E} \cdot \mathbf{E} + c^2 \mathbf{B} \cdot \mathbf{B}) \right]. \quad (1.56)$$

## Summary of important concepts and equations

### Electro-motive force $\mathcal{E}$ (emf)

- A non-conservative force per charge  $\mathbf{E}_{\text{EM}}$  which acts inside a source of emf to maintain a

voltage across its terminals

- Examples include batteries and electrical generators
- The total electric field includes any (conservative) electrostatic field  $\mathbf{E}_{\text{ES}}$  such that

$$\mathcal{E} = \int_{\text{inside source}} \mathbf{E}_{\text{EM}} \cdot d\mathbf{r} = \oint_{\text{via source}} \mathbf{E}_{\text{EM}} \cdot d\mathbf{r} = \oint_{\text{via source}} (\mathbf{E}_{\text{EM}} + \mathbf{E}_{\text{ES}}) \cdot d\mathbf{r}. \quad (1.57)$$

### Faraday's law

- The emf around circuit  $\Gamma$  is minus the rate of change of magnetic flux through surface  $S$  bounded by the circuit,

$$\oint_{\Gamma} \mathbf{E} \cdot d\mathbf{r} = -\frac{d}{dt} \int_S \mathbf{B} \cdot d\mathbf{S}$$

- The negative sign is because the emf drives a current which tries to oppose change (Lenz's law)

Excellent Economics and Business programmes at:



university of  
 groningen




“The perfect start  
 of a successful,  
 international career.”

**CLICK HERE**  
 to discover why both socially  
 and academically the University  
 of Groningen is one of the best  
 places for a student to be

[www.rug.nl/feb/education](http://www.rug.nl/feb/education)

- In differential form  $\nabla \times \mathbf{E} = -\frac{\partial \mathbf{B}}{\partial t}$ ,  $\mathbf{E} = -\frac{\partial \mathbf{A}}{\partial t}$
- Including both conservative and non-conservative fields  $\mathbf{E} = -\nabla V - \frac{\partial \mathbf{A}}{\partial t}$

### Inductance

- Mutual inductance: magnetic flux in one circuit due to current in another  $M = \Phi_2/I_1$
- Self inductance: magnetic flux in a circuit due to current in the same circuit  $L = \Phi_1/I_1$
- Work done to produce magnetic field  $W = \frac{1}{2}LI^2$
- Energy density in magnetic field  $u = \frac{1}{2}\mathbf{H} \cdot \mathbf{B} = \frac{1}{2}HB = \frac{1}{2}\mu H^2 = \frac{1}{2\mu}B^2$

### Maxwell's equations

- Maxwell modified Ampere's Law to make  $\nabla \cdot (\nabla \times \mathbf{B}) = 0$ ,

$$\nabla \times \mathbf{B} = \mu_0 \mathbf{J} + \mu_0 \varepsilon_0 \frac{\partial \mathbf{E}}{\partial t}$$

- Displacement current density:  $\mathbf{J}_D \equiv \varepsilon_0 \left( \frac{\partial \mathbf{E}}{\partial t} \right)$
- Gauss' law, the no magnetic charge law  $\nabla \cdot \mathbf{B} = 0$ , Ampere's law (modified) and Faraday's law are collectively referred to as Maxwell's equations.
- These four equations unify electricity and magnetism and together with the Lorentz force law encapsulate classical electrodynamics

### Energy and momentum conservation

- Energy conservation is expressed by Poynting's theorem
- The flow of electromagnetic energy is described by the Poynting vector  $\mathbf{S} = \mathbf{E} \times \mathbf{H}$  whose direction gives the direction of energy flow and whose magnitude gives the energy crossing unit area per unit time

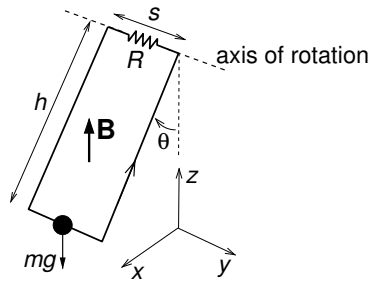
- Electromagnetic momentum density is  $\mathbf{g} = \varepsilon_0 \mathbf{E} \times \mathbf{B} = \mu_0 \varepsilon_0 \mathbf{E} \times \mathbf{H} = \mathbf{S}/c^2$
- The flow of electromagnetic momentum into closed surface  $S$  is given by

$$\sum_i \hat{\mathbf{e}}_i \oint_S \left( \sum_j T_{ij} \hat{\mathbf{e}}_j \cdot \hat{\mathbf{n}} \right) dS, \quad (1.58)$$

where  $\hat{\mathbf{n}}$  is the outward normal unit vector and  $T_{ij}$  is the Maxwell stress tensor.

## Exercises on Chapter 1

- 1–1 A magnetic dipole of moment  $\mathbf{m} = m\hat{\mathbf{z}}$  is located at the origin. A thin circular conducting ring of radius  $a$  vibrates such that the position of its centre is  $\mathbf{r} = [z_0 + b \cos(\omega t)]\hat{\mathbf{z}}$  with  $b \ll a \ll z_0$ . The plane of the ring remains parallel to the  $x$ – $y$  plane during the vibration. Find the emf around the ring in the  $\phi$  direction.
- 1–2 A thin disc of radius  $a$  and height  $h$  contains charge  $+q$  uniformly distributed throughout the disc. The disc is located with its centre at the origin, and rotates about the  $z$ -axis with angular velocity  $\boldsymbol{\omega} = \omega\hat{\mathbf{z}}$ .
- (a) Using cylindrical coordinates but with  $R$  being the cylindrical radius to avoid confusion with the charge density  $\rho(\mathbf{r})$ , specify the current density  $\mathbf{J}(R, \phi, z)$  as a function of position. In the limit  $h \ll a$  find the magnetic dipole moment.
- (b) Consider a circular loop of radius  $R_0$  around the  $z$ -axis at height  $z_0$  above the disc for the case  $R_0 \ll a \ll z_0$ . Find the magnetic flux through the loop, and hence find the vector potential at the loop.
- (c) If, due to friction in the axle, the disc's angular velocity is decreasing exponentially with time  $t$  as  $\omega(t) = \omega_0 e^{-t/t_0}$ , where  $t_0$  is the decay time scale, find the electric field at the loop at time  $t = 0$ .
- 1–3 A light rigid rectangular circuit with resistance  $R$  has mass  $m$  attached to the middle of the lower side (width  $s$ ), and the top side is suspended horizontally using frictionless bearings to form a simple pendulum of length  $h$  as shown in the diagram below. In the absence of a magnetic field the position of the pendulum mass would be described by  $\mathbf{r}_m(t) \approx h \theta_0 \cos(\omega t) \hat{\mathbf{x}}$  where  $\omega = \sqrt{g/h}$ . A uniform magnetic field  $\mathbf{B}$  points in the vertically upward direction.



(a) Assuming the position of the pendulum mass is still described by  $\mathbf{r}_m(t) \approx h \theta_0 \cos(\omega t) \hat{\mathbf{x}}$ , what is the magnetic flux  $\Phi_B(t)$  through the circuit, and hence the emf as a function of time? Take the direction around the circuit indicated by the arrow to correspond to positive emfs and currents.

(b) What is the force on the lower side of the circuit due to the magnetic field? What is the instantaneous work done by the pendulum *against* this force? Compare this with instantaneous power dissipated in the circuit? What are the consequences of the presence of the magnetic field for the motion of the pendulum?

1–4 Consider the section of a two-wire transmission line shown below. Show that the self-inductance per unit length for the case where  $D \gg a$  is given by

## American online LIGS University

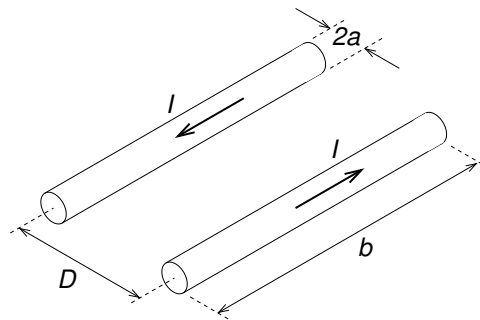
is currently enrolling in the  
Interactive Online **BBA, MBA, MSc,**  
**DBA and PhD** programs:

- ▶ enroll **by September 30th, 2014** and
- ▶ **save up to 16%** on the tuition!
- ▶ pay in 10 installments / 2 years
- ▶ Interactive **Online** education
- ▶ visit [www.ligsuniversity.com](http://www.ligsuniversity.com) to  
find out more!

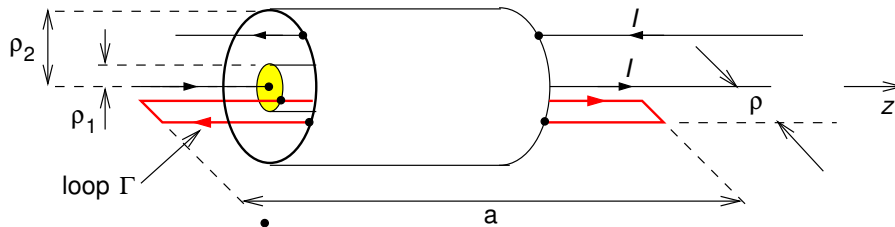
Note: LIGS University is not accredited by any nationally recognized accrediting agency listed by the US Secretary of Education. More info [here](#).



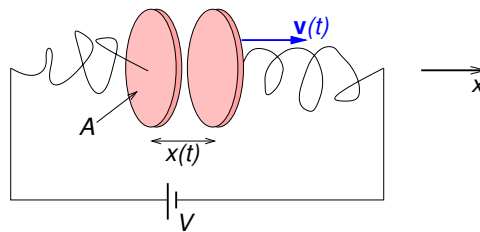
$$L = \frac{\mu_0}{\pi} \ln \frac{D}{a}. \tag{1.59}$$



1-5 Consider a coaxial cable as an infinite cylindrical inductor and find the inductance per unit length.



1-6 The diagram shows a parallel plate capacitor. Find the current  $I(t)$ , and the displacement current density  $\mathbf{J}_D$  between moving capacitor plates, and check that the total displacement current is  $I_D(t) = I(t)$ . Neglect fringing effects.



1-7 Consider a straight piece of wire radius  $a$  and length  $\Delta z$ , along which current  $I$  is flowing. The potential difference between the ends is  $\Delta V$ . Find the Poynting vector at the surface of the wire and use it to determine the rate at which energy flows into the wire, and compare the result with Joules's law.

1-8 A long solenoid carrying a time-dependent current  $I(t)$  is wound on a hollow cylinder whose axis of symmetry is the  $z$ -axis. The solenoid's radius is  $a$ , and it has  $n$  turns per metre.

- (a) Write down the magnetic intensity  $\mathbf{H}(\mathbf{r}, t)$  and magnetic field  $\mathbf{B}(\mathbf{r}, t)$  everywhere. What is the energy density in the magnetic field inside the solenoid?
- (b) Find the electric field  $\mathbf{E}(\mathbf{r}, t)$  everywhere using Faraday's law in integral form.
- (c) Find the magnetic vector potential  $\mathbf{A}(\mathbf{r}, t)$  everywhere.
- (d) Find the Poynting vector  $\mathbf{S}(\mathbf{r}, t)$  inside the cylinder, and hence the energy flux into a section of the cylinder of length  $h$  and the rate of increase of energy density inside the cylinder. Compare this with the rate of increase of magnetic field energy inside length  $h$  of the cylinder.
- 1–9 Using the Maxwell stress tensor find the pressure exerted on a perfectly absorbing screen by an electromagnetic plane wave at normal incidence.

**DON'T EAT YELLOW SNOW**

What will your advice be?

Some advice just states the obvious. But to give the kind of advice that's going to make a real difference to your clients you've got to listen critically, dig beneath the surface, challenge assumptions and be credible and confident enough to make suggestions right from day one. At Grant Thornton you've got to be ready to kick start a career right at the heart of business.

Sound like you? Here's our advice: visit [GrantThornton.ca/careers/students](http://GrantThornton.ca/careers/students)

Scan here to learn more about a career with Grant Thornton.



 **Grant Thornton**  
An instinct for growth™

© Grant Thornton LLP. A Canadian Member of Grant Thornton International Ltd



## 2 Electromagnetic waves in empty space and linear dielectrics

### Learning objectives

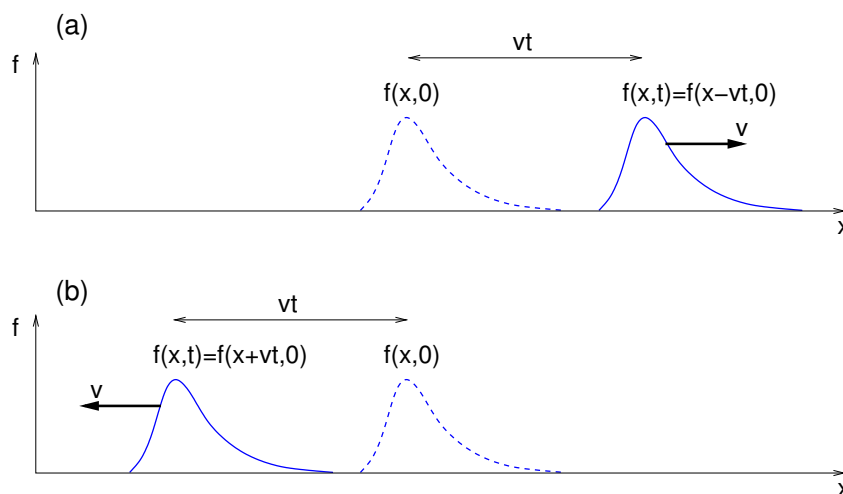
- To revise solutions of the 1D wave equation, and to understand the meaning of the wavelength, frequency, phase, phase constant, angular frequency and phase velocity for its sinusoidal solutions, and how they are related.
- To know that EM waves can propagate along transmission lines, to be able to obtain the wave equation for a lossless transmission line of given inductance per unit length  $L$  and capacitance per unit length  $C$ , and to find the characteristic impedance  $Z = \sqrt{L/C}$  and phase velocity  $v_p = 1/\sqrt{LC} = 1/\sqrt{\mu\varepsilon}$ .
- To know that the 3D wave equation  $\nabla^2 f = \frac{1}{v^2} \frac{\partial^2 f}{\partial t^2}$  has monochromatic plane wave solutions  $f(\mathbf{r}, t) = f_0 \exp[i(\mathbf{k} \cdot \mathbf{r} - \omega t)]$  where  $\mathbf{k}$  is the wave vector.
- To be able to derive the wave equation for EM waves in a linear medium  $\nabla^2 \mathbf{E} - \mu\varepsilon \frac{\partial^2 \mathbf{E}}{\partial t^2} = 0$ , the phase velocity  $v_p = 1/\sqrt{\mu\varepsilon}$ , the wave impedance of the medium  $Z = \sqrt{\varepsilon/\mu}$ , the solution  $\mathbf{E}(\mathbf{r}, t) = \mathbf{E}_0 \exp[i(\mathbf{k} \cdot \mathbf{r} - \omega t)]$  and how it relates to  $\mathbf{B}$  and  $\mathbf{k}$ , and find the energy density, Poynting vector and intensity.
- To understand the polarisation terminology needed for reflection and refraction, including the plane of incidence, and to be able to derive the laws of reflection and refraction, and to apply the amplitude reflection and transmission coefficients, calculating reflectance and transmittance, Brewster's angle and the critical angle for total internal reflection.

### 2.1 The wave equation and its monochromatic plane wave solutions

I will start with a discussion of the one-dimensional (1D) wave equation and its general solution before moving on to sinusoidal waves. Next, the amplitude, wavelength, frequency, wave number, phase velocity and angular frequency will be defined, and the relationships between them given. The concept of a complex wave function with its real part representing a physical quantity will then be introduced, the 1D wave equation will be generalised to three-dimensions (3D), and the monochromatic plane wave solutions to the 3D wave equation will be given in complex form.

In the simplest case (Fig. 2.1), a wave pulse travels through a non-dispersive medium at constant

speed  $v$  and with a fixed shape. The wave function  $f(x, t)$  represents a physical quantity, e.g. pressure, displacement,  $y$ -component of magnetic field, etc.



**Figure 2.1:** A wave pulse travelling (a) in the  $+x$  direction, and (b) in the  $-x$  direction, at speed  $v$  in a non-dispersive medium.

In the above examples the wave functions are,

$$(a) \quad f(x, t) = f(x - vt, 0) = \psi_+(x - vt), \quad (2.1)$$

$$(b) \quad f(x, t) = f(x + vt, 0) = \psi_-(x + vt), \quad (2.2)$$

where  $\psi_+$  and  $\psi_-$  could be any differentiable functions. A linear superposition of these two functions provides the general solution of the *one-dimensional wave equation*

$$\frac{\partial^2 f}{\partial x^2} = \frac{1}{v^2} \frac{\partial^2 f}{\partial t^2} \quad (2.3)$$

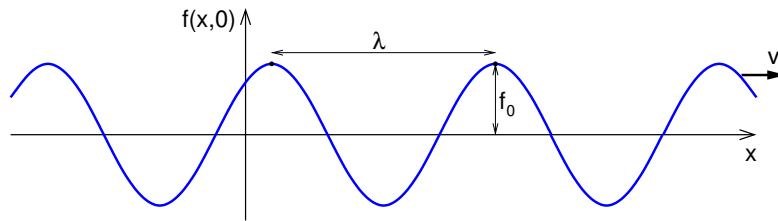
and represent waves travelling in the  $+x$  and  $-x$  directions, respectively. By partial differentiation with respect to  $x$  and  $t$  one can easily show that  $f(x, t) = \psi_+(x - vt)$  satisfies the wave equation:

$$\frac{\partial^2 f}{\partial x^2} = \psi_+''(x - vt); \quad \frac{1}{v^2} \frac{\partial^2 f}{\partial t^2} = \frac{1}{v^2} (-v)^2 \psi_+''(x - vt) = \psi_+''(x - vt). \quad (2.4)$$

One can similarly prove that  $\psi_-(x + vt)$  is also a solution of the wave equation.

The sinusoidal wave  $f(x, t) = f_0 \cos[k(x - vt) + \delta]$  shown in Fig. 2.2 has the form  $\psi_+(x - vt)$  and so it must satisfy the wave equation. Adjacent maxima are separated by one *wavelength*

$\lambda = 2\pi/k$  where  $k$  is the *wave number*. At any position  $x$  the wave function  $f(x, t)$  representing a physical quantity oscillates at *frequency*  $\nu = v/\lambda$ . At time  $t$  the wave function maximises at positions where the *phase*,  $[k(x - vt) + \delta]$ , equals  $2n\pi$  where  $n$  is an integer and  $\delta$  is the *phase constant*.



**Figure 2.2:** A sinusoidal wave with wavelength  $\lambda$  travelling in the  $x$  direction at speed  $v$  in a non-dispersive medium.

It is usual to write a sinusoidal wave in terms of its wave number  $k = 2\pi/\lambda$  and *angular frequency*  $\omega = vk = 2\pi\nu$ ,

$$f(x, t) = f_0 \cos(kx - \omega t + \delta). \quad (2.5)$$

In this case, if  $k$  is positive the wave travels in the  $+x$  direction, and if  $k$  is negative the wave travels in the  $-x$  direction. Usually engineers prefer to write  $f(x, t) = f_0 \cos(\omega t - kx + \delta)$  for a wave travelling in the  $+x$  direction.

In classical physics it is often convenient for the wave function to be complex, and to write it in terms of complex exponentials. Then its real part represents the physical quantity. (Caution: this is different to the wave function  $\Psi(x, t)$  encountered in quantum mechanics whose modulus squared represents probability density.) Then the physical quantity is

$$f(x, t) = |f_0| \operatorname{Re} \left\{ e^{i(kx - \omega t + \delta)} \right\} = \operatorname{Re} \left\{ f_0 e^{i(kx - \omega t)} \right\} = |f_0| \cos(kx - \omega t + \delta) \quad (2.6)$$

where  $i \equiv \sqrt{-1}$  and  $f_0 = |f_0|e^{i\delta}$  is the complex amplitude. From now on, whenever we see a complex quantity the physical quantity is to be understood to be its real part.

The wave functions represented by Eqs. 2.5 and 2.6 are *monochromatic* (from the ancient Greek for single-colour - in general single-frequency) solutions of the wave equation, unlike the impulse of Fig. 2.1 which Fourier analysis would show to contain a broad range of frequencies. Note that engineers usually prefer to use  $j$  as the symbol representing  $\sqrt{-1}$ , and would write  $f(x, t) = \text{Re} \{ f_0 e^{j(\omega t - kx)} \}$  for a wave travelling in the  $+x$  direction.

In reality waves travel in three-dimensions, and generalising the one-dimensional wave equation (Eq. 2.3) to three dimensions gives the three-dimensional wave equation

$$\frac{\partial^2 f}{\partial x^2} + \frac{\partial^2 f}{\partial y^2} + \frac{\partial^2 f}{\partial z^2} = \frac{1}{v^2} \frac{\partial^2 f}{\partial t^2}, \quad \text{or} \quad \nabla^2 f = \frac{1}{v^2} \frac{\partial^2 f}{\partial t^2}. \quad (2.7)$$

It has monochromatic *plane wave* solutions

$$f(\mathbf{r}, t) = f_0 \exp[i(\mathbf{k} \cdot \mathbf{r} - \omega t)] \quad (2.8)$$

where, as before,  $f_0$  is in general complex and the (real) physical quantity is understood to be the real part of the complex solution. Notice that  $kx$  in the 1D equation is replaced by  $\mathbf{k} \cdot \mathbf{r}$

.....Alcatel-Lucent 

[www.alcatel-lucent.com/careers](http://www.alcatel-lucent.com/careers)

What if you could build your future and create the future?

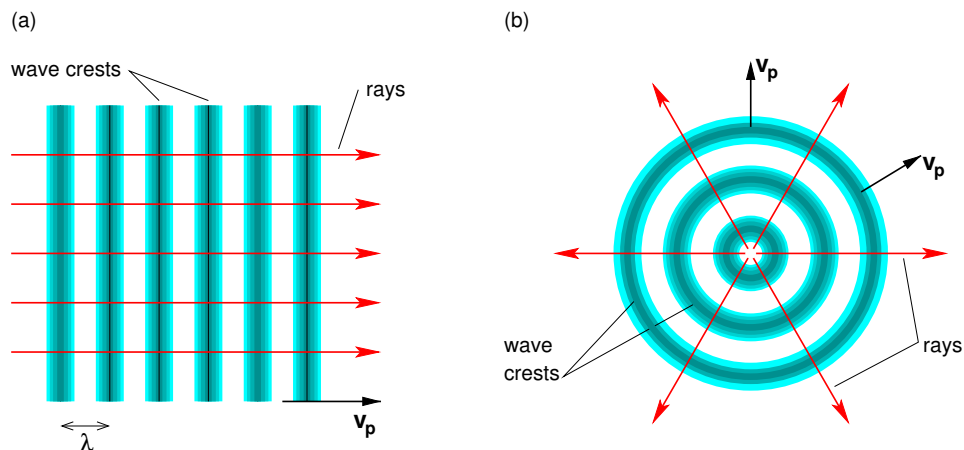
One generation's transformation is the next's status quo. In the near future, people may soon think it's strange that devices ever had to be "plugged in." To obtain that status, there needs to be "The Shift".



where  $\mathbf{k}$  is the *wave vector*. Its magnitude is just the wave number  $k = 2\pi/\lambda$  as before, and the wave propagates in the direction of  $\mathbf{k}$ . The field  $f(\mathbf{r}, t)$  is *identical* at all points at which the phase is

$$(\mathbf{k} \cdot \mathbf{r} - \omega t) = 2n\pi + \text{const.}, \quad (\text{integer } n), \quad (2.9)$$

i.e. in planes perpendicular to  $\mathbf{k}$  separated by integer multiples of  $\lambda$ . Lines drawn perpendicular to these planes of constant phase, i.e. parallel to  $\mathbf{k}$ , are called *rays* (see Fig. 2.3a); a concept useful in ray optics.



**Figure 2.3:** Wave crests and rays of (a) a plane wave, and (b) a spherical wave.

The speed  $v$  actually gives the speed at which the phase propagates, the *phase velocity*,

$$v_p = \frac{\omega}{k}. \quad (2.10)$$

If there is dispersion, i.e. different frequencies propagate at different velocities, then  $k = k(\omega)$  and in Chapter 3 we will need to distinguish the phase velocity from the velocity at which wave-packets propagate, the group velocity  $v_g$ . For this reason, from now on I will use  $v_p$  rather than  $v$  to represent the wave velocity in non-dispersive media. As we shall shortly see,  $v_p = c$  for electromagnetic waves in a vacuum.

Another important class of solutions of the 3D wave equation are the spherical waves (see Fig. 2.3b)

$$f(\mathbf{r}, t) = f_0 r^{-1} \exp[i(kr - \omega t)] \quad (\text{spherical wave travelling outwards from origin}) \quad (2.11)$$

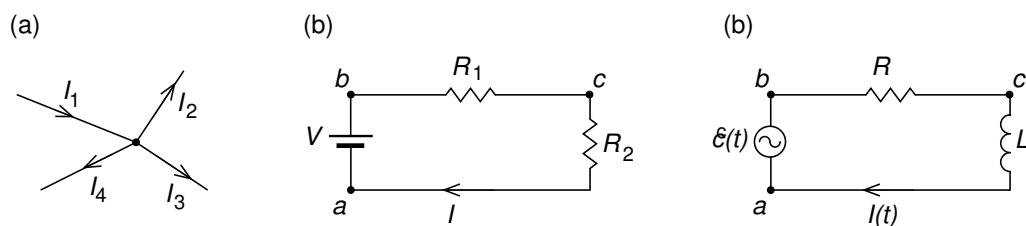
$$f(\mathbf{r}, t) = f_0 r^{-1} \exp[i(-kr - \omega t)] \quad (\text{spherical wave travelling in towards origin}). \quad (2.12)$$

The wave intensity is the energy transported per unit time through unit area perpendicular to the wave direction. This is proportional to square of wave function, and for spherical waves is proportional to  $r^{-2}$ . In the case of outgoing spherical waves this is the well known “inverse square law” which applies equally to the sound or light intensity from point sources. Examples of spherical waves travelling inwards include a convex lens or concave mirror focusing light waves to a point, and radio waves from a distant source being focused by a radio telescope dish onto a small antenna at its focus.

## 2.2 Transmission lines

Transmission lines are electrical cables which consist of two parallel conductors of uniform cross section, usually separated by a dielectric, and which are designed to transmit radio frequency ( $\sim$ kHz to  $\sim$ 300 MHz) signals from one place to another. Examples include twin lead (two parallel wires), coaxial cable and the strip line. At lower frequencies (50 Hz or 60 Hz) overhead power lines are used to transmit electricity from a remote generating station to a city. At microwave frequencies ( $\sim$  300 MHz to  $\sim$  300 GHz) waveguides are used, for infrared frequencies specialised waveguides are made of layers of different dielectrics, and at optical frequencies we see the application of optical fibres. In this section we shall only discuss transmission lines which comprise two parallel conductors.

We will consider a section of a transmission line as if it were an electrical circuit, and so we need to briefly review the circuit rules due to German physicist Gustav Kirchoff (1824–1887). His first rule, the junction rule, expresses conservation of charge – it requires that the rate at which charge flows into a junction must equal the rate at which charge flows out of that junction. This is conveniently expressed in terms of currents as: “at any point, the sum of all currents entering a junction must equal the sum of all currents leaving that junction”. For the junction shown in Fig. 2.4(a) this implies  $I_2 + I_3 + I_4 = I_1$ .



**Figure 2.4:** Circuits to illustrate (a) Kirchoff's junction rule, and (b) Kirchoff's loop rule.

Kirchhoff's 2st rule, the loop rule, expresses energy conservation, and requires for DC circuits that the sum of the changes in potential around any closed path of a circuit must be zero. For the circuit shown in Fig. 2.4(b) which, from Ohm's law, has current  $I = V/(R_1 + R_2)$  flowing around it this implies

$$V_{ba} + V_{cb} + V_{ac} = 0. \quad \therefore V - \frac{V}{R_1 + R_2}R_1 - \frac{V}{R_1 + R_2}R_2 = 0. \quad (2.13)$$

In AC circuits which include inductors, the electric field is not conservative and so the potential is undefined. However, we can still use Kirchhoff's 2nd rule if for the change across an inductor we use the emf. Hence, for the AC circuit in Fig. 2.4(c) we have

$$\mathcal{E}(t) - I(t)R - L\frac{dI}{dt} = 0. \quad (2.14)$$



Join the best at  
the Maastricht University  
School of Business and  
Economics!

#### Top master's programmes

- 33<sup>rd</sup> place Financial Times worldwide ranking: MSc International Business
- 1<sup>st</sup> place: MSc International Business
- 1<sup>st</sup> place: MSc Financial Economics
- 2<sup>nd</sup> place: MSc Management of Learning
- 2<sup>nd</sup> place: MSc Economics
- 2<sup>nd</sup> place: MSc Econometrics and Operations Research
- 2<sup>nd</sup> place: MSc Global Supply Chain Management and Change

Sources: Keuzegids Master ranking 2013; Elsevier 'Beste Studies' ranking 2012; Financial Times Global Masters in Management ranking 2012

Maastricht University is the best specialist university in the Netherlands (Elsevier)

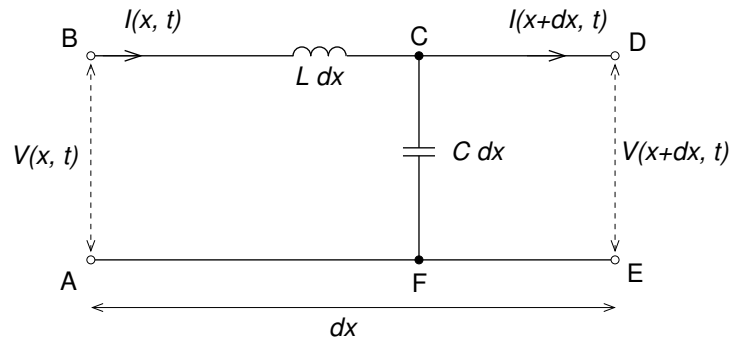
Visit us and find out why we are the best!  
Master's Open Day: 22 February 2014

[www.mastersopenday.nl](http://www.mastersopenday.nl)



### 2.2.1 Lossless transmission line equations

We will only discuss lossless transmission lines, i.e. where there is no resistance present between or along the conductors. Then the equivalent circuit of infinitesimal length  $dx$  is shown in Fig. 2.5. Note that here and in the following equations  $L$  is the inductance per unit length and  $C$  is the capacitance per unit length.



**Figure 2.5:** Equivalent circuit of infinitesimal length  $dx$  of a lossless transmission line.

Applying Kirchhoff's loop rule to loop ABDEA,

$$V(x, t) - L dx \frac{\partial I(x, t)}{\partial t} - V(x + dx, t) = 0, \quad (2.15)$$

and Kirchhoff's junction rule to junction C gives

$$I(x, t) - C dx \frac{\partial V(x, t)}{\partial t} - I(x + dx, t) = 0. \quad (2.16)$$

From these we obtain the *lossless transmission line equations* also known as the *telegraphers' equations*

$$-\frac{\partial V(x, t)}{\partial x} = L \frac{\partial I(x, t)}{\partial t}, \quad (2.17)$$

$$-\frac{\partial I(x, t)}{\partial x} = C \frac{\partial V(x, t)}{\partial t}. \quad (2.18)$$

Differentiating Eq. 2.17 with respect to  $x$  and Eq. 2.18 with respect to  $t$ ,

$$-\frac{\partial^2 V(x, t)}{\partial x^2} = L \frac{\partial^2 I(x, t)}{\partial x \partial t}, \quad -\frac{\partial^2 I(x, t)}{\partial t \partial x} = C \frac{\partial^2 V(x, t)}{\partial t^2}. \quad (2.19)$$



Then, eliminating  $\partial^2 I / \partial x \partial t$ , we get

$$\therefore \frac{\partial^2 V(x, t)}{\partial x^2} - LC \frac{\partial^2 V(x, t)}{\partial t^2} = 0, \quad (2.20)$$

which is the wave equation for  $V(x, t)$  on a lossless transmission line.

If instead we differentiate Eq. 2.17 with respect to  $t$  and Eq. 2.18 with respect to  $x$ , and then eliminate  $\partial^2 V / \partial x \partial t$ , we get

$$-\frac{\partial^2 V(x, t)}{\partial t \partial x} = L \frac{\partial^2 I(x, t)}{\partial t^2}, \quad -\frac{\partial^2 I(x, t)}{\partial x^2} = C \frac{\partial^2 V(x, t)}{\partial x \partial t}. \quad (2.21)$$

$$\therefore \frac{\partial^2 I(x, t)}{\partial x^2} - LC \frac{\partial^2 I(x, t)}{\partial t^2} = 0, \quad (2.22)$$

which is the wave equation for  $I(x, t)$  on a lossless transmission line.

Equations 2.20 and 2.22 are in the form of the 1D wave equation (Eq. 2.3), and so we see that signals must travel along transmission lines as waves with phase velocity

$$v_p = \frac{1}{\sqrt{LC}}. \quad (2.23)$$

For harmonic time-dependence with angular frequency  $\omega$  we can use complex exponentials

$$V(x, t) = V_f e^{i(kx - \omega t)} + V_b e^{i(-kx - \omega t)}, \quad I(x, t) = I_f e^{i(kx - \omega t)} + I_b e^{i(-kx - \omega t)}, \quad (2.24)$$

where  $k = \omega / v_p$ , and  $V_f$  and  $V_b$  are the complex voltage amplitudes of waves propagating in the forward and backwards directions, i.e. in the positive and negative  $x$ -directions (we take the real parts for the actual voltage and current). Similarly,  $I_f$  and  $I_b$  are the complex current amplitudes of waves propagating in the positive and negative  $x$ -directions.

The characteristic impedance of the transmission line is

$$Z = \frac{V_f}{I_f} = \frac{V_b}{I_b}. \quad (2.25)$$

We can obtain the characteristic impedance by substituting one of the harmonic solutions, say

for the forward wave in Eq. 2.24, into one of the transmission line equations, say Eq. 2.17. Then

$$-ik V_f e^{i(kx-\omega t)} = -i\omega L I_f e^{i(kx-\omega t)}, \tag{2.26}$$

$$\therefore Z = \frac{\omega L}{k} = v_p L = \frac{L}{\sqrt{LC}} = \sqrt{\frac{L}{C}}. \tag{2.27}$$

As an example, we consider two types of transmission line, the two-wire transmission line (Fig. 2.6a) and the coaxial cable (Fig. 2.6b).

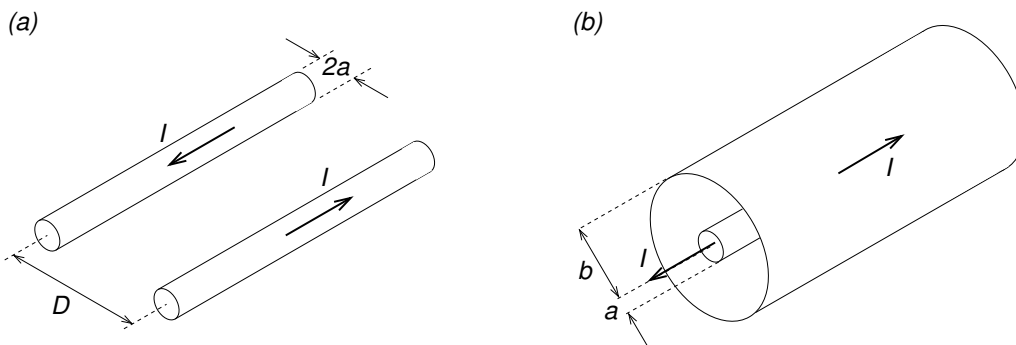


Figure 2.6: Geometry of (a) two-wire transmission line, (b) coaxial cable.

**BI**  
NORWEGIAN  
BUSINESS SCHOOL

EFMD  
**EQUIS**  
ACCREDITED

## Empowering People. Improving Business.

BI Norwegian Business School is one of Europe's largest business schools welcoming more than 20,000 students. Our programmes provide a stimulating and multi-cultural learning environment with an international outlook ultimately providing students with professional skills to meet the increasing needs of businesses.

BI offers four different two-year, full-time Master of Science (MSc) programmes that are taught entirely in English and have been designed to provide professional skills to meet the increasing need of businesses. The MSc programmes provide a stimulating and multi-cultural learning environment to give you the best platform to launch into your career.

- MSc in Business
- MSc in Financial Economics
- MSc in Strategic Marketing Management
- MSc in Leadership and Organisational Psychology

[www.bi.edu/master](http://www.bi.edu/master)



For the two-wire transmission line

$$L = \frac{\mu}{\pi} \ln\left(\frac{D}{a}\right), \quad C = \frac{\pi\varepsilon}{\ln\left(\frac{D}{a}\right)}, \quad (2.28)$$

and so

$$v_p = \frac{1}{\sqrt{\mu\varepsilon}}, \quad Z = \frac{1}{\pi} \sqrt{\frac{\mu}{\varepsilon}} \ln\left(\frac{D}{a}\right). \quad (2.29)$$

For the coaxial cable line

$$L = \frac{\mu}{2\pi} \ln\left(\frac{b}{a}\right), \quad C = \frac{2\pi\varepsilon}{\ln\left(\frac{b}{a}\right)}, \quad (2.30)$$

and so

$$v_p = \frac{1}{\sqrt{\mu\varepsilon}}, \quad Z = \frac{1}{2\pi} \sqrt{\frac{\mu}{\varepsilon}} \ln\left(\frac{b}{a}\right). \quad (2.31)$$

Notice that in both cases  $v_p$  is the same and equal to  $(\mu\varepsilon)^{-1/2}$  for the insulating material having permeability  $\mu$  and permittivity  $\varepsilon$  — this is true for any lossless transmission line — but that  $Z$  depends on the geometry (type and dimensions) of the transmission line.

### 2.2.2 Standing waves on a lossless transmission line

Unless the line is terminated with the characteristic impedance there will also be reflected waves traveling in the  $-x$  direction, and the wave amplitude will be the sum of incident and reflected components. If the line is open-circuit, i.e. nothing connected to output terminals, the resistance is infinite. In this case the reflected wave will be inverted and the result will be a standing wave. To see this let's apply the boundary condition on the current, namely at the open circuited end the current must be zero as the charge cannot move in or out of the open-circuit end of the transmission line. If we set the open-circuit end of the transmission line to be at  $x = 0$ , then we must have

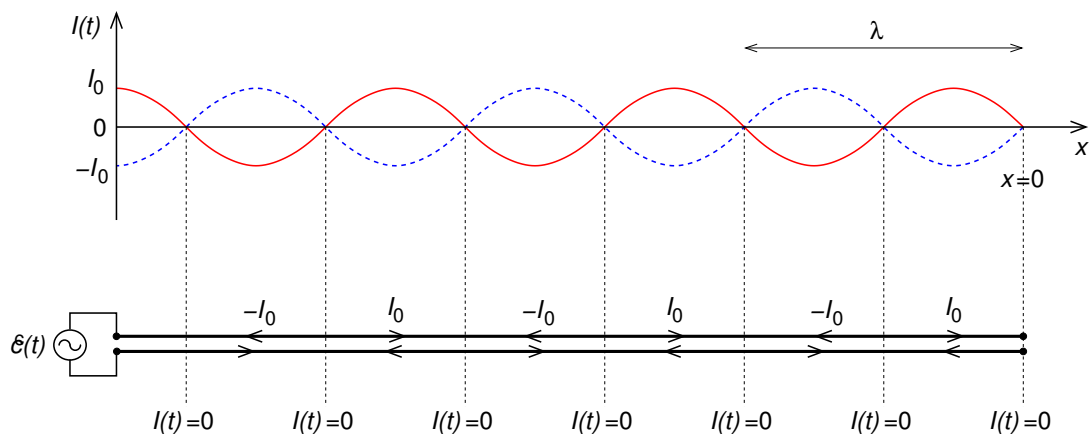
$$I(0, t) = I_f e^{-i\omega t} + I_b e^{-i\omega t} = 0. \quad (2.32)$$

This condition can only be met for all  $t$  if  $I_b = -I_f$ , i.e. total reflection with the reflected wave inverted. For convenience, we can set  $I_b = I_0/2i$ , and then we have

$$I(x, t) = I_0 \frac{e^{ikx} - e^{-ikx}}{2i} e^{-i\omega t} = I_0 \sin(kx) e^{-i\omega t}. \quad (2.33)$$

Taking the real part, we have a standing wave as in Fig. 2.7,

$$I(x, t) = I_0 \sin(kx) \cos(\omega t). \quad (2.34)$$



**Figure 2.7:** The current as a function of position along an open circuited lossless transmission line is a standing wave: red solid curve — current at  $t = nT$  where  $n$  is an integer and  $T = 2\pi/\omega$  is the period; blue dashed curve — current at  $t = (n + \frac{1}{2})T$ . Note that current nodes (where  $I = 0$ ) occur at every half wavelength from the open-circuit end where  $x = 0$ ; the wavelength is  $\lambda = 2\pi/k$ . The lower plot shows direction of current flow in each conductor at  $t = nT$ .

## 2.3 EM waves in vacuum and linear media

Starting with Maxwell's equations, we shall shortly derive the wave equations for the electric and magnetic fields and show that they predict the existence of electromagnetic (EM) waves in free space travelling at speed  $c$ . The relationships between the fields, the wave vector and angular frequency for a valid monochromatic EM plane wave will be determined, and the energy density, Poynting vector and wave intensity will be derived. Since monochromatic EM plane waves are an idealisation, we discuss when this may be a good approximation for quasi-monochromatic EM waves through introducing the concepts of coherence.

As I shall shortly show, Maxwell's (1865) theory predicted the existence of electromagnetic

waves travelling at the speed of light. Experiments by Hertz in 1886, in which he produced and detected radio waves, provided proof of Maxwell's theory. At the time it was thought that a medium was required for propagation of EM waves. This "luminiferous aether" was supposed to be at rest while the Earth moved through it – spinning around its axis once a day while orbiting the Sun once per year, as the Sun orbits around the centre of the Galaxy, etc.

If the aether were fixed, while the Earth moved through it, then the light transit time over a fixed baseline on Earth would depend on the orientation of the baseline with respect to the "aether wind". In 1887 Michelson and Morley, and later experimenters, found that there was actually no difference with orientation, proving that there is no aether and that EM waves can propagate without a medium. This is unique, as all other classical waves require a medium to propagate in (e.g. sound waves in air).

To show that EM waves in a vacuum are indeed allowed, we need to derive their wave equation. We will actually derive the wave equation for a charge-free and current-free linear medium. The results we obtain for this case can easily be specialised to the vacuum case by setting  $\mu \rightarrow \mu_0$  and  $\varepsilon \rightarrow \varepsilon_0$ .

## Need help with your dissertation?

Get in-depth feedback & advice from experts in your topic area. Find out what you can do to improve the quality of your dissertation!

Get Help Now



Go to [www.helpmyassignment.co.uk](http://www.helpmyassignment.co.uk) for more info



Helpmyassignment

First, take the curl of Faraday's law, giving

$$\nabla \times (\nabla \times \mathbf{E}) = \nabla \times \left( -\frac{\partial \mathbf{B}}{\partial t} \right) = -\frac{\partial}{\partial t} (\nabla \times \mathbf{B}). \quad (2.35)$$

Next, using the 2nd derivative rule  $\nabla \times (\nabla \times \mathbf{a}) = \nabla(\nabla \cdot \mathbf{a}) - \nabla^2 \mathbf{a}$  we get

$$\nabla(\nabla \cdot \mathbf{E}) - \nabla^2 \mathbf{E} = -\frac{\partial}{\partial t} (\nabla \times \mathbf{B}). \quad (2.36)$$

In a charge-free region  $\nabla \cdot \mathbf{E} = \rho/\varepsilon_0 = 0$ , and we can use Ampère's law to replace  $\nabla \times \mathbf{B}$ :

$$0 - \nabla^2 \mathbf{E} = -\frac{\partial}{\partial t} \left[ \mu \mathbf{J} + \mu \varepsilon \left( \frac{\partial \mathbf{E}}{\partial t} \right) \right]. \quad (2.37)$$

Hence, for a charge-free ( $\rho = 0$ ) and current-free region ( $\mathbf{J} = 0$ )

$$\nabla^2 \mathbf{E} - \mu \varepsilon \frac{\partial^2 \mathbf{E}}{\partial t^2} = 0 \quad (\text{Wave Eqn. for } \mathbf{E}). \quad (2.38)$$

We can derive the wave equation for  $\mathbf{B}$  in a similar way by taking the curl of Ampère's law, using the same 2nd derivative rule, and finally using Faraday's law to obtain

$$\nabla^2 \mathbf{B} - \mu \varepsilon \frac{\partial^2 \mathbf{B}}{\partial t^2} = 0 \quad (\text{Wave Eqn. for } \mathbf{B}). \quad (2.39)$$

Equations 2.38 and 2.39 are identical in form to three-dimensional wave equation (Eq. 2.7), and this shows that Maxwell's equations predict that EM waves are able to propagate through a linear material with phase velocity

$$v_p = \frac{1}{\sqrt{\mu \varepsilon}}. \quad (2.40)$$

We also see that EM waves can propagate in a vacuum ( $\mu = \mu_0$ ,  $\varepsilon = \varepsilon_0$ ), and the phase velocity of electromagnetic waves in vacuum, i.e. the speed of light, is

$$c = \frac{1}{\sqrt{\mu_0 \varepsilon_0}} \equiv 299792458 \text{ m s}^{-1}. \quad (2.41)$$

The monochromatic plane wave solutions of Eqs. 2.38 and 2.39 are

$$\mathbf{E}(\mathbf{r}, t) = \mathbf{E}_0 \exp[i(\mathbf{k} \cdot \mathbf{r} - \omega t)] \quad \text{and} \quad \mathbf{B}(\mathbf{r}, t) = \mathbf{B}_0 \exp[i(\mathbf{k} \cdot \mathbf{r} - \omega t)]. \quad (2.42)$$

Although these are solutions of the wave equation, they are not valid EM waves unless they also satisfy Maxwell's equations. What constitutes a valid EM wave is discussed next.

### 2.3.1 Relationships between $\mathbf{k}$ , $\mathbf{E}$ , $\mathbf{B}$ and $\mathbf{H}$

The monochromatic plane wave solutions must have  $\mathbf{E}_0$ ,  $\mathbf{B}_0$ ,  $\omega$  and  $\mathbf{k}$  such that  $\mathbf{E}$  and  $\mathbf{B}$  are consistent with Maxwell's equations. To find the relationships between  $\mathbf{k}$ ,  $\mathbf{E}$  and  $\mathbf{B}$  we shall need the time derivative, divergence and curl of  $\mathbf{E} = \mathbf{E}_0 e^{i(\mathbf{k} \cdot \mathbf{r} - \omega t)}$  and  $\mathbf{B} = \mathbf{B}_0 e^{i(\mathbf{k} \cdot \mathbf{r} - \omega t)}$ , as given below, which are derived in Appendix C,

$$\frac{\partial}{\partial t} \mathbf{E} = -i\omega \mathbf{E}, \quad \nabla \cdot \mathbf{E} = i\mathbf{k} \cdot \mathbf{E}, \quad \nabla \times \mathbf{E} = i\mathbf{k} \times \mathbf{E}, \quad (2.43)$$

$$\frac{\partial}{\partial t} \mathbf{B} = -i\omega \mathbf{B}, \quad \nabla \cdot \mathbf{B} = i\mathbf{k} \cdot \mathbf{B}, \quad \nabla \times \mathbf{B} = i\mathbf{k} \times \mathbf{B}. \quad (2.44)$$

Putting  $\mathbf{E} = \mathbf{E}_0 e^{i(\mathbf{k} \cdot \mathbf{r} - \omega t)}$  and  $\mathbf{B} = \mathbf{B}_0 e^{i(\mathbf{k} \cdot \mathbf{r} - \omega t)}$  into Maxwell's equations (with  $\rho = 0$  and  $\mathbf{J} = 0$ ) we obtain

$$\nabla \cdot \mathbf{E} = 0 \quad \longrightarrow \quad \mathbf{k} \cdot \mathbf{E} = 0, \quad (2.45)$$

$$\nabla \cdot \mathbf{B} = 0 \quad \longrightarrow \quad \mathbf{k} \cdot \mathbf{B} = 0, \quad (2.46)$$

$$\nabla \times \mathbf{E} = -\frac{\partial \mathbf{B}}{\partial t} \quad \longrightarrow \quad \mathbf{k} \times \mathbf{E} = \omega \mathbf{B}, \quad (2.47)$$

$$\nabla \times \mathbf{B} = \mu\epsilon \frac{\partial \mathbf{E}}{\partial t} \quad \longrightarrow \quad \mathbf{k} \times \mathbf{B} = -\mu\epsilon\omega \mathbf{E}. \quad (2.48)$$

We see immediately that  $\mathbf{k}$ ,  $\mathbf{E}$  and  $\mathbf{B}$  are orthogonal vectors as  $\mathbf{k} \cdot \mathbf{E} = 0$ ,  $\mathbf{k} \cdot \mathbf{B} = 0$  and  $\mathbf{E} \cdot \mathbf{B} = \mathbf{E} \cdot (\mathbf{k} \times \mathbf{E})/\omega = 0$ . Hence, the EM field of a valid monochromatic EM plane wave is described by

$$\mathbf{E}(\mathbf{r}, t) = \mathbf{E}_0 \exp[i(\mathbf{k} \cdot \mathbf{r} - \omega t)], \quad (2.49)$$

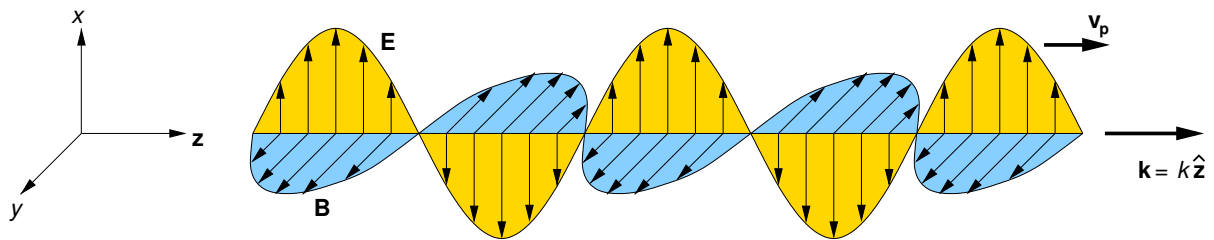
$$\mathbf{B}(\mathbf{r}, t) = \omega^{-1} \mathbf{k} \times \mathbf{E}(\mathbf{r}, t), \quad (2.50)$$

subject to  $\mathbf{k} \cdot \mathbf{E}_0 = 0$ . Finally, since  $v_p = \omega/k = (\mu\varepsilon)^{-1/2}$ ,

$$B(\mathbf{r}, t) = \sqrt{\mu\varepsilon} E(\mathbf{r}, t) = \frac{1}{v_p} E(\mathbf{r}, t), \quad (2.51)$$

$$H(\mathbf{r}, t) = \frac{1}{\mu} B(\mathbf{r}, t) = \sqrt{\frac{\varepsilon}{\mu}} E(\mathbf{r}, t) \equiv \frac{1}{Z} E(\mathbf{r}, t), \quad (2.52)$$

where the constant  $Z$  is called the wave impedance of the medium, and for free space takes the value  $Z_0 \equiv \sqrt{\mu_0/\varepsilon_0} \approx 377 \Omega$ . Fig. 2.8 is a cartoon showing the  $\mathbf{E}$ ,  $\mathbf{B}$ ,  $\mathbf{k}$  and  $\mathbf{v}_p$  vectors for a monochromatic EM plane wave.



**Figure 2.8:** The electric and magnetic fields of a monochromatic EM plane wave travelling in the  $+z$  direction with the electric field in the  $\pm x$  direction and magnetic field in the  $\pm y$  direction.

# Brain power



Plug into The Power of Knowledge Engineering.  
Visit us at [www.skf.com/knowledge](http://www.skf.com/knowledge)

By 2020, wind could provide one-tenth of our planet's electricity needs. Already today, SKF's innovative know-how is crucial to running a large proportion of the world's wind turbines.

Up to 25 % of the generating costs relate to maintenance. These can be reduced dramatically thanks to our systems for on-line condition monitoring and automatic lubrication. We help make it more economical to create cleaner, cheaper energy out of thin air.

By sharing our experience, expertise, and creativity, industries can boost performance beyond expectations. Therefore we need the best employees who can meet this challenge!

The Power of Knowledge Engineering





### 2.3.2 Energy and momentum in electromagnetic waves

Since for an EM wave  $B = \sqrt{\mu\varepsilon} E$ , the electric and magnetic contributions to energy density are equal,

$$\frac{\varepsilon E^2}{2} = \frac{B^2}{2\mu}, \quad (2.53)$$

and so the total energy density in the EM wave is

$$u = \left( \frac{\varepsilon E^2}{2} + \frac{B^2}{2\mu} \right) = \varepsilon E^2 = \frac{B^2}{\mu}, \quad (2.54)$$

$$\therefore u(\mathbf{r}, t) = \varepsilon E_0^2 \cos^2(\mathbf{k} \cdot \mathbf{r} - \omega t + \delta). \quad (2.55)$$

The energy flux is given by the Poynting vector  $\mathbf{S} = \mathbf{E} \times \mathbf{H}$ , and for EM waves in a linear non-dispersive medium this is

$$\mathbf{S} = \mathbf{E} \times \left[ \frac{1}{\mu} \omega^{-1} \mathbf{k} \times \mathbf{E} \right] = \frac{\sqrt{\mu\varepsilon}}{\mu} E^2 \hat{\mathbf{k}} = \frac{1}{\sqrt{\mu\varepsilon}} \varepsilon E^2 \hat{\mathbf{k}} = v_p \varepsilon E^2 \hat{\mathbf{k}}. \quad (2.56)$$

$$\therefore \mathbf{S}(\mathbf{r}, t) = v_p u(\mathbf{r}, t) \hat{\mathbf{k}}. \quad (2.57)$$

The *intensity* ( $\text{W m}^{-2}$ ) of the wave is the time-average of the magnitude of the Poynting vector

$$I = v_p \varepsilon |E_0|^2 \langle \cos^2(\mathbf{k} \cdot \mathbf{r} - \omega t + \delta) \rangle = v_p \frac{\varepsilon |E_0|^2}{2}. \quad (2.58)$$

Since the momentum density is  $\mathbf{g} = \mathbf{S}/c^2$  (as discussed in Chapter 1), the momentum flux of an EM wave is  $v_p \mathbf{g}$ . Its magnitude is just the amount of momentum crossing unit area of a surface perpendicular to  $\hat{\mathbf{k}}$  per unit time, and we may use it to find the radiation pressure. If a parallel beam of radiation is perfectly absorbed then the radiation pressure is

$$p_{\text{rad,abs}} = \frac{v_p}{c^2} \langle S \rangle = \frac{v_p^2}{c^2} \langle u \rangle \quad (2.59)$$

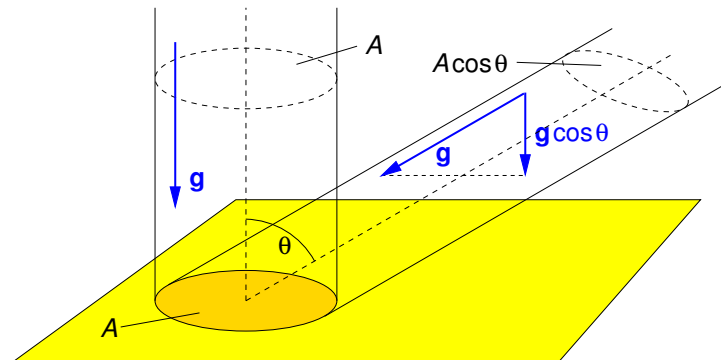
whereas if the radiation is perfectly reflected then the radiation pressure is twice as large.

To obtain the radiation pressure of isotropic radiation we need to integrate the momentum

flux incident on area  $A$  of one side of a plane surface, taking only the component of momentum density perpendicular to the plane, i.e.  $\mathbf{g} \cos \theta$ , and the projected area  $A \cos \theta$  (Fig. 2.9),

$$p_{\text{rad,iso}} = \frac{1}{A} \int_0^1 \frac{v_p^2}{c^2} \langle u \rangle \cos \theta A \cos \theta d \cos \theta = \frac{1}{3} \frac{v_p^2}{c^2} \langle u \rangle. \quad (2.60)$$

Note that the radiation pressure in empty space is  $p = u/3$ , and this is the equation of state of a photon gas.



**Figure 2.9:** Geometry used in calculating the radiation pressure of isotropic EM radiation.

## 2.4 Coherence of EM waves

The monochromatic plane wave solutions are an idealisation because they are of infinite extent in all directions and are pure sinusoidal waves, i.e. the spread in angular frequencies is  $\Delta\omega = 0$ . The same is true of monochromatic spherical waves. Such waves are completely *coherent*. Two identical copies of such waves, say each with amplitude  $E_0$  and peak intensity  $I_0 = (\epsilon_0/2)E_0^2c$ , can be made to interfere in a predictable way and show interference fringes alternating between 100% constructive interference with  $I_{\text{max}} = (\epsilon_0/2)(E_0 + E_0)^2c = 4I_0$  and 100% destructive interference with  $I_{\text{min}} = (\epsilon_0/2)(E_0 - E_0)^2c = 0$ , such that the *visibility* of the fringes is

$$V \equiv \frac{I_{\text{max}} - I_{\text{min}}}{I_{\text{max}} + I_{\text{min}}} = 1. \quad (2.61)$$

Real EM waves are only partially coherent, but they may display coherence at a particular location over a limited time called the *coherence time*  $t_c$ , due to a partially coherent wave train of length equal to the *coherence length*  $l_c = v_p t_c$  passing through that location. The width

of the wave front across which coherence is maintained is called the *coherence width*  $d_c$ . The criterion for determining these parameters is the time, or distance, over which the phase differs significantly from that of a pure sinusoidal wave. The coherence time, length or width may be used to determine the conditions under which a monochromatic EM plane wave may be a good approximation to the EM field present.

Spectral line emission can be considered *quasi-monochromatic*, but even then there will be a narrow range of frequencies about the nominal transition frequency. Thus any source of EM waves will in practice produce waves of finite extent and have a spread of frequencies. For example, for an atomic transition the *natural line width* is  $\Delta\omega \sim \Gamma$  where  $\Gamma$  is the spontaneous transition rate (Einstein A coefficient for spontaneous emission).

Fourier theory shows that  $\Delta x \Delta k_x \sim 1$ . Given that  $v_p = \omega/k$ , and that for a wave travelling in the  $\hat{x}$  direction  $k_x = k$ , it follows that  $\Delta k_x = \Delta\omega/v_p$  such that the wave trains associated with emitted photons will have a coherence length

$$l_c = \Delta x \sim \frac{v_p}{\Gamma} \quad (2.62)$$

## TURN TO THE EXPERTS FOR SUBSCRIPTION CONSULTANCY

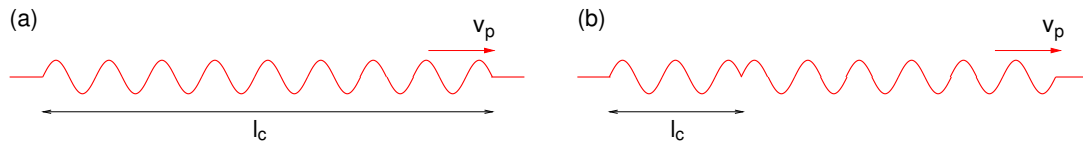
Subscribe is one of the leading companies in Europe when it comes to innovation and business development within subscription businesses.

We innovate new subscription business models or improve existing ones. We do business reviews of existing subscription businesses and we develop acquisition and retention strategies.

Learn more at [linkedin.com/company/subscribe](https://www.linkedin.com/company/subscribe) or contact Managing Director Morten Suhr Hansen at [mha@subscribe.dk](mailto:mha@subscribe.dk)

**SUBSCRIBE** - to the future

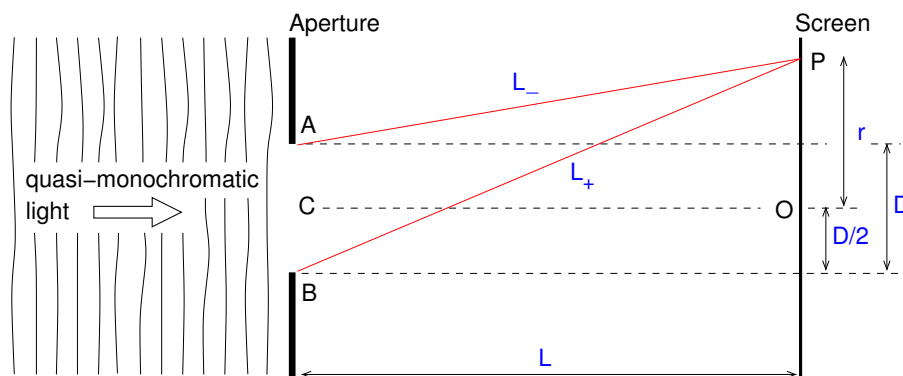
as illustrated in Fig. 2.10(a). As an example, consider the Sodium D lines which have  $\lambda \approx 590$  nm and  $\Gamma \approx 6.1 \times 10^7$  s<sup>-1</sup>, for which we find that  $\ell_c \sim 5$  m or about 8 million wavelengths.



**Figure 2.10:** (a) A finite EM wave train due to an atomic transition. (b) A phase shift resulting from a collision during the transition. The coherence length  $\ell_c$  is the smallest coherent part of the wave train.

In practice, the coherence time will be shorter and the observed width of a spectral line broader. If, for example, during the transition the atom collides with another atom then a phase shift is introduced, and the coherence length will be reduced accordingly (Fig. 2.10b). This effect becomes more important with increasing density and temperature and is referred to as *pressure broadening*. Also, because of thermal motion, the frequency of a photon emitted by an individual atom will be doppler shifted by an amount depending on the atom's component of velocity toward the observer. This *Doppler broadening* produces a gaussian line shape with line-width proportional to  $\sqrt{T}$ .

To determine the coherence width consider a source of diameter  $D$ , represented as an aperture illuminated by a quasi-monochromatic plane wave in Fig. 2.11 and a screen a distance  $L$  away. Consider the EM field at point O on the screen. It has contributions from the entire source (all points between A and B). These contributions will have a definite phase at O provided the difference between paths AO and CO is much less than half a wavelength, and this is equivalent to the condition  $kD^2 \ll L$ .



**Figure 2.11:** Geometry used in estimating the coherence width.

As we move across the screen away from point O to point P coherence will be lost as the difference between paths AP and CP becomes comparable to half a wavelength (phase difference  $\Delta\phi = \pi$ ). The distance  $r_c$  where this occurs is the radius of a patch of the wavefront called the

coherence area,  $A_c = \pi r_c^2$ , over which the wavefront may be considered spatially coherent (the coherence width is  $d_c = 2r_c$ ). The phase difference is  $\Delta\phi = k(L_+ - L_-) \approx krD/L$  provided  $D < r \ll L$ . Then,

$$d_c = \frac{2\pi L}{kD} = \frac{\lambda L}{D}. \quad (2.63)$$

There exist both artificial and natural sources of coherent EM waves. One example of a natural source of coherent radiation is an astrophysical maser where a molecular line in the microwave region of the spectrum is observed. Maser stands for microwave amplification by stimulated emission of radiation. Astrophysical masers occur in shocked regions in molecular clouds in the Galaxy. An upper long-lived level of a molecular species is “pumped” by collisional excitation or infrared photons giving rise to a population inversion (more molecules in the upper level than in the lower level they decay to). This population inversion causes stimulated emission to dominate over absorption, resulting in a negative absorption coefficient.

A single photon from spontaneous decay can initiate maser action. As it propagates through the region of the molecular cloud having the population inversion the photon triggers repeated stimulated emission of essentially *identical* photons in phase with itself, as do the photons produced by stimulated emission. There is thus a cascade or avalanche in which the number of photons build up exponentially with distance, and because the path-lengths through the cloud are huge the resulting brightness (intensity per unit solid angle) of coherent microwave radiation is sufficiently high to be observable with radio telescopes.

Artificial sources of coherent EM radiation include both masers and lasers. In the laboratory, artificial masers using hyperfine splitting of the 21cm line spin-flip transition of the ground state of neutral atomic hydrogen in a weak magnetic field (Zeeman effect discussed in Chapter 6 of “Essential Electromagnetism”) are used as a frequency standard.

The *laser* (light amplification by stimulated emission of radiation) has many practical applications and works on the same principle as the astrophysical maser just discussed. The main differences are that transitions typically in the optical or infrared are used, and various methods (depending on the medium) are used to pump the upper (metastable) level. Also, in the laser, the enormous path lengths needed are achieved by having a laser cavity containing the laser medium between two parallel mirrors in which the light is reflected back and forth, with some small fraction escaping from one of the mirrors (which is partially transmitting) to form a laser beam.

The subject of coherence (and the closely-related field of quantum optics) is important in physical optics and is a field in its own right of which we have just skimmed the surface, but suffice it to say here that the electromagnetic field in the centre of a laser beam is an excellent approximation to that of a monochromatic EM plane wave, and that many of the results I shall derive in the remainder of this chapter for monochromatic plane waves will apply also to partially coherent quasi-monochromatic beams.

## 2.5 Polarisation of EM waves

In this section linear, circular and elliptical polarisations will be described in terms of the electric field of a monochromatic plane wave propagating in the  $+z$  direction which can be written

$$\mathbf{E}(\mathbf{r}, t) = (E_{0,x}e^{i\delta_x}\hat{\mathbf{x}} + E_{0,y}e^{i\delta_y}\hat{\mathbf{y}})e^{i(kz-\omega t)}. \quad (2.64)$$

The actual field is

What do you want to do?

No matter what you want out of your future career, an employer with a broad range of operations in a load of countries will always be the ticket. Working within the Volvo Group means more than 100,000 friends and colleagues in more than 185 countries all over the world. We offer graduates great career opportunities – check out the Career section at our web site [www.volvogroup.com](http://www.volvogroup.com). We look forward to getting to know you!

**VOLVO**  
AB Volvo (publ)  
[www.volvogroup.com](http://www.volvogroup.com)

VOLVO TRUCKS | RENAULT TRUCKS | MACK TRUCKS | VOLVO BUSES | VOLVO CONSTRUCTION EQUIPMENT | VOLVO PENTA | VOLVO AERO | VOLVO IT  
VOLVO FINANCIAL SERVICES | VOLVO 3P | VOLVO POWERTRAIN | VOLVO PARTS | VOLVO TECHNOLOGY | VOLVO LOGISTICS | BUSINESS AREA ASIA

$$\operatorname{Re}\{\mathbf{E}(\mathbf{r}, t)\} = \hat{\mathbf{x}}E_{0,x} \cos(kz - \omega t + \delta_x) + \hat{\mathbf{y}}E_{0,y} \cos(kz - \omega t + \delta_y). \quad (2.65)$$

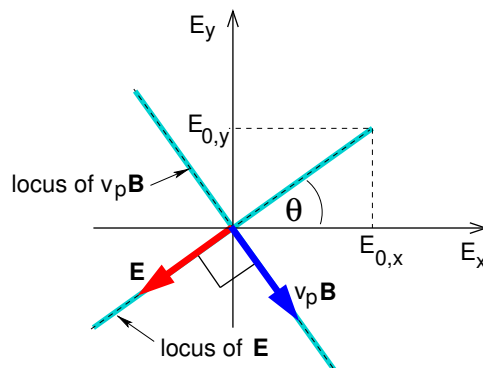
Depending on the ratio of  $E_{0,y}$  to  $E_{0,x}$  and the relative phase  $(\delta_y - \delta_x)$  the monochromatic plane wave will be linearly, circularly or elliptically polarised.

### 2.5.1 Linear polarisation

In linear polarisation the two phase constants are equal,  $\delta_y = \delta_x \equiv \delta$ , and so

$$\operatorname{Re}\{\mathbf{E}(\mathbf{r}, t)\} = (\hat{\mathbf{x}}E_{0,x} + \hat{\mathbf{y}}E_{0,y}) \cos(kz - \omega t + \delta). \quad (2.66)$$

The locus of the tip of the  $\mathbf{E}$  vector performs simple harmonic motion along a line at angle  $\theta = \arctan(E_{0,y}/E_{0,x})$  to the  $E_x$ -axis in the  $E_x$ - $E_y$  plane as shown in Fig. 2.12. This means that the EM wave is linearly polarised (plane polarised) such that the electric field direction is at angle  $\theta$  to the  $x$ -axis. Fig. 2.8 already showed  $\mathbf{E}$  and  $\mathbf{B}$  for a linearly polarised wave. Linearly polarised quasi-monochromatic plane waves may be produced by passing unpolarised light through a monochromatic filter and then through a polariser such as Polaroid film, or better still by passing a laser beam through a polariser.



**Figure 2.12:** The locus of the tip of the  $\mathbf{E}$  vector and the  $v_p \mathbf{B}$  vector in the  $E_x$ - $E_y$  plane for the case of linear polarisation.

## 2.5.2 Circular and elliptical polarisation

In both circular and elliptical polarisation the electric and magnetic field vectors rotate with angular frequency  $\omega$ . In circular polarisation  $E_{0,y} = E_{0,x} \equiv E_0$  and  $(\delta_y - \delta_x) = \pm\pi/2$ , so that the locus of the tip of the  $\mathbf{E}$  vector undergoes circular motion with “radius”  $E_0$  in the  $E_x$ - $E_y$  plane and angular frequency  $\omega$ , as shown in the Fig. 2.13(a). This means that the EM wave is circularly polarised. There are two possibilities depending on the sign of  $(\delta_y - \delta_x)$ , usually referred to in optics textbooks as right or left polarisation, or to use particle physics nomenclature negative or positive helicity, respectively. Note that we are free to define  $\delta_x = 0$ .

When discussing Faraday rotation in Chapter 3 it will be useful to use new complex basis vectors for circularly polarised waves propagating in the  $+\hat{\mathbf{z}}$  direction,

$$\mathbf{e}_R = (\hat{\mathbf{x}} - i\hat{\mathbf{y}}), \quad \mathbf{e}_L = (\hat{\mathbf{x}} + i\hat{\mathbf{y}}). \quad (2.67)$$

Note that these basis vectors are not actually unit vectors as their magnitudes are both  $\sqrt{2}$  rather than 1 (I have deliberately omitted the hat symbol), but we shall find them useful in their unnormalised form in Chapter 3. Then for right circular polarisation,

$$\mathbf{E}(\mathbf{r}, t) = E_0 \mathbf{e}_R e^{i(kz - \omega t)} = E_0 (\hat{\mathbf{x}} + e^{-i\pi/2} \hat{\mathbf{y}}) e^{i(kz - \omega t)}. \quad (2.68)$$

$$\therefore \text{Re}\{\mathbf{E}(\mathbf{r}, t)\} = E_0 [\hat{\mathbf{x}} \cos(kz - \omega t + \delta_x) + \hat{\mathbf{y}} \sin(kz - \omega t + \delta_x)], \quad (2.69)$$

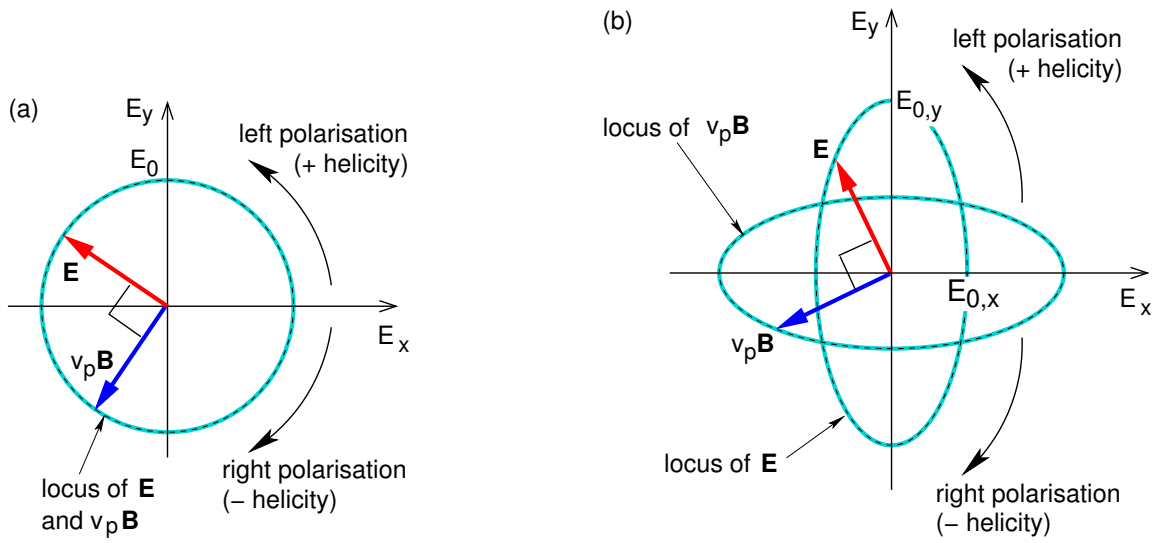
and for left circular polarisation,

$$\mathbf{E}(\mathbf{r}, t) = E_0 \mathbf{e}_L e^{i(kz - \omega t)} = E_0 (\hat{\mathbf{x}} + e^{+i\pi/2} \hat{\mathbf{y}}) e^{i(kz - \omega t)}. \quad (2.70)$$

$$\therefore \text{Re}\{\mathbf{E}(\mathbf{r}, t)\} = E_0 [\hat{\mathbf{x}} \cos(kz - \omega t + \delta_x) - \hat{\mathbf{y}} \sin(kz - \omega t + \delta_x)]. \quad (2.71)$$

In Fig. 2.13(a) we are located at some fixed  $z$ , and view the wave coming towards us. If you bend your fingers and point your thumbs *in the direction of the source* of the wave (i.e. thumbs point in the  $-\hat{\mathbf{z}}$  direction), and if the fingers of your right hand curl in the direction of rotation of the  $\mathbf{E}$  vector then the polarisation is “right-handed”. Fig. 2.14 shows a wave which is right-circularly polarised. Note that this is the usual convention used in optics.





**Figure 2.13:** Loci of the tips of the  $\mathbf{E}$  and  $v_p \mathbf{B}$  vectors in the  $E_x$ - $E_y$  plane as observed at fixed  $z$  for (a) circular polarisation and (b) elliptical polarisation. (The wave is propagating in the  $+\hat{z}$  direction.)

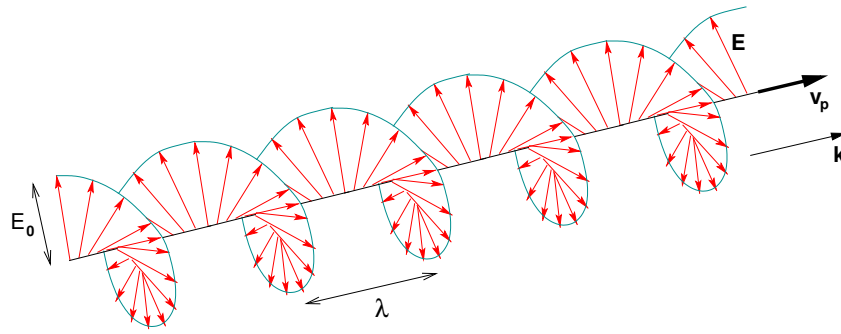
**gaiTeye**  
Challenge the way we run

**EXPERIENCE THE POWER OF FULL ENGAGEMENT...**

**RUN FASTER.  
RUN LONGER..  
RUN EASIER...**

**READ MORE & PRE-ORDER TODAY  
WWW.GAITEYE.COM**





**Figure 2.14:** Electric field of an EM wave with right circular polarisation. Note that as viewed looking toward the source of the wave from a fixed point the  $\mathbf{E}$  vector rotates clockwise.

In elliptical polarisation the tip of the  $\mathbf{E}$  vector rotates with angular velocity  $\omega$  tracing an ellipse in the  $E_x$ - $E_y$  plane. In the most general case the major axis of the ellipse is at some arbitrary angle with respect to the  $x$  or  $y$  direction. However without loss of generality we could carry out a rotation of coordinates such that the major axis is parallel to either the  $x$  or the  $y$  axis such that  $(\delta_y - \delta_x) = \pm\pi/2$  as in circular polarisation. Then

$$\operatorname{Re}\{\mathbf{E}(\mathbf{r}, t)\} = \hat{\mathbf{x}}E_{0,x} \cos(kz - \omega t + \delta_x) + \hat{\mathbf{y}}E_{0,y} \sin(kz - \omega t + \delta_x) \quad (\text{right}), \quad (2.72)$$

$$\operatorname{Re}\{\mathbf{E}(\mathbf{r}, t)\} = \hat{\mathbf{x}}E_{0,x} \cos(kz - \omega t + \delta_x) - \hat{\mathbf{y}}E_{0,y} \sin(kz - \omega t + \delta_x) \quad (\text{left}). \quad (2.73)$$

An example with  $E_{0,y} > E_{0,x}$  is shown in Fig. 2.13(b).

## 2.6 Reflection and transmission of EM waves at an interface between linear media

In this section I will start by deriving the laws of reflection and refraction. The *refractive index* of a linear medium is defined by

$$n \equiv \frac{c}{v_p} = \frac{ck}{\omega} = \sqrt{\frac{\mu\varepsilon}{\mu_0\varepsilon_0}} \approx \sqrt{\frac{\varepsilon}{\varepsilon_0}} \quad (2.74)$$

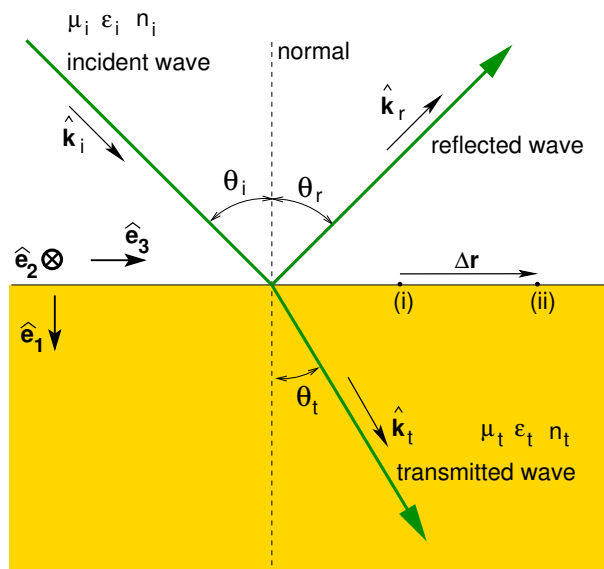
where the final approximation  $\mu \approx \mu_0$  applies to non-magnetic materials.

Since  $k = \omega/v_p$  for monochromatic EM plane waves

$$\mathbf{B}(\mathbf{r}, t) = \frac{1}{\omega} \mathbf{k} \times \mathbf{E}(\mathbf{r}, t) = \frac{1}{v_p} \hat{\mathbf{k}} \times \mathbf{E}(\mathbf{r}, t) = \frac{n}{c} \hat{\mathbf{k}} \times \mathbf{E}(\mathbf{r}, t). \quad (2.75)$$

### 2.6.1 Laws of reflection and refraction

Consider a monochromatic plane EM wave incident on a plane boundary between two dielectric materials. Part of the wave is transmitted and part is reflected. From symmetry arguments, the reflected and transmitted rays must be in the same plane as the incident ray and the normal to the boundary. This plane is called the *plane of incidence*. Fig. 2.15 shows the ray geometry in the plane of incidence.



**Figure 2.15:** Incident, reflected and transmitted rays shown in the plane of incidence.

We use subscripts  $i$ ,  $r$  and  $t$  to refer to quantities related to the incident, reflected and transmitted waves, respectively. We also use subscript  $i$  to indicate the material in which the incident wave (and reflected wave) propagates, and subscript  $t$  to indicate the material in which the transmitted wave propagates.

The electric and magnetic fields of the incident, reflected and transmitted waves are

$$\mathbf{E}_i = E_{i,0} \exp\{i(\mathbf{k}_i \cdot \mathbf{r} - \omega_i t)\} \quad (\text{incident wave}), \quad (2.76)$$

$$\mathbf{E}_r = E_{r,0} \exp\{i(\mathbf{k}_r \cdot \mathbf{r} - \omega_r t)\} \quad (\text{reflected wave}), \quad (2.77)$$

$$\mathbf{E}_t = E_{t,0} \exp\{i(\mathbf{k}_t \cdot \mathbf{r} - \omega_t t)\} \quad (\text{transmitted wave}), \quad (2.78)$$

$$\mathbf{B} = \frac{n}{c} \hat{\mathbf{k}} \times \mathbf{E} \quad (\text{for each wave}). \quad (2.79)$$

The electromagnetic field must satisfy the boundary conditions for  $\mathbf{E}$ ,  $\mathbf{D}$ ,  $\mathbf{B}$  and  $\mathbf{H}$  at every point on the interface between the two materials at all times. For the boundary conditions to

hold at *all times*,  $\omega$  must be the same for all three waves.

For the boundary conditions to be satisfied at *every point*, e.g. simultaneously at points “(i)” and “(ii)” in Fig. 2.15,

$$\mathbf{k}_i \cdot \Delta \mathbf{r} = \mathbf{k}_r \cdot \Delta \mathbf{r} = \mathbf{k}_t \cdot \Delta \mathbf{r}. \quad (2.80)$$

$$\therefore k_i \sin \theta_i = k_r \sin \theta_r = k_t \sin \theta_t. \quad (2.81)$$

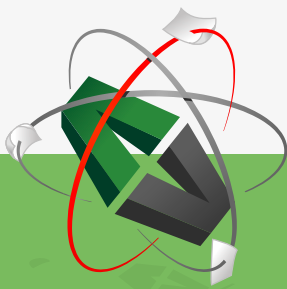
Since  $k_i = k_r$  because the incident and reflected waves propagate in the same medium, we have

$$\theta_i = \theta_r \quad (\text{law of reflection}). \quad (2.82)$$

Similarly, since  $k = \omega/v_p = \omega n/c$  and  $\omega$  is the same for all waves,

$$n_i \sin \theta_i = n_t \sin \theta_t \quad (\text{law of refraction or “Snell’s Law”}). \quad (2.83)$$

This e-book  
is made with  
**SetaPDF**



PDF components for PHP developers

[www.setasign.com](http://www.setasign.com)



We now know what the directions of the reflected and transmitted waves are, but how much of the incident intensity is reflected or transmitted? The *reflectance*,  $R$ , also known as the reflectivity, is the fraction of the incident power that is reflected. The *transmittance*,  $T$ , also known as the transmissivity, is the fraction of the incident power that is transmitted. We shall see that the reflectance and transmittance are different if the orientation of the plane of polarisation with respect to the plane of incidence, is parallel or perpendicular to the plane of incidence.

In general, the incident wave can be treated as a superposition of two linearly polarised waves whose planes of polarisation are orthogonal, with one wave polarised parallel to, and the other perpendicular to, the plane of incidence. This is equivalent in quantum mechanics to the wave function being a superposition of eigenstates of the system. The polarisation terminology to be used is discussed in the next section.

### 2.6.2 Polarisation terminology for reflection and refraction

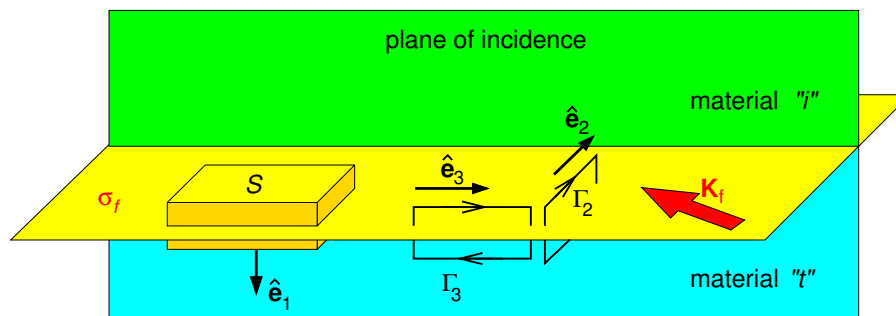
Polarisation perpendicular to the plane of incidence is written as “ $\sigma$ ”, “ $s$ ” or “TE mode”, and in equations as “ $\perp$ ”. Polarisation parallel to the plane of incidence is written as “ $\pi$ ”, “ $p$ ” or “TM mode”, and in equations as “ $\parallel$ ”. This confusing nomenclature comes from the German and Greek,  $s$  for *senkrecht* (perpendicular) and  $p$  for *parallel* (parallel), and their Greek letter equivalents. TE mode refers to transverse electric, i.e. in this case  $\mathbf{E}$  is perpendicular to the plane of incidence, and TM mode (transverse magnetic mode) is when  $\mathbf{B}$  is perpendicular to the plane of incidence. I shall not use this nomenclature here because the incident, reflected and transmitted waves of both polarisations are actually all TEM waves, i.e. transverse electromagnetic waves with both  $\mathbf{E}$  and  $\mathbf{B}$  perpendicular (transverse to) to  $\mathbf{k}$ . I shall instead reserve this nomenclature for when I discuss waveguides where there are wave field components parallel to  $\mathbf{k}$ , with TE waves having no component of  $\mathbf{E}$  parallel to  $\mathbf{k}$ , and TM waves having no component of  $\mathbf{B}$  parallel to  $\mathbf{k}$ .

## 2.7 Fresnel equations

In the following sections we shall obtain the *Fresnel equations* for the amplitude reflection coefficients, and the reflectance and transmittance versus the angle of incidence  $\theta$  for the two polarisations.

### 2.7.1 Boundary conditions at interface

As an electromagnetic wave intersects the interface between two dielectrics, it is the boundary conditions on the electromagnetic field that determine the properties of the reflected and transmitted waves. In the dielectric where the incident wave is present, the electric and magnetic fields are the vector sums of those of the incident and reflected waves. The boundary conditions that need satisfying can be derived from Maxwell's equations in integral form and are the same as were derived in "Essential Electromagnetism". The relevant geometry is shown in Fig. 2.16 together with the Gaussian pillbox and Amperian loops to be used.



**Figure 2.16:** Gaussian pillbox and Amperian loops straddling the interface to be used in determining the boundary conditions on the EM wave fields.

The Gaussian pillbox is to be used with Gauss' law  $\oint \mathbf{D} \cdot d\mathbf{S} = q_{f,\text{encl.}}$  and the no-magnetic-charge law  $\oint \mathbf{B} \cdot d\mathbf{S} = 0$ . The pillbox is infinitesimally thin and so we are only concerned with free surface charge, but in our case we have  $\sigma_f = 0$ . Hence,

$$\varepsilon_i(\mathbf{E}_i + \mathbf{E}_r) \cdot \hat{\mathbf{e}}_1 = \varepsilon_t \mathbf{E}_t \cdot \hat{\mathbf{e}}_1 \quad (\text{B.C. on } \mathbf{D}), \quad (2.84)$$

$$(\mathbf{B}_i + \mathbf{B}_r) \cdot \hat{\mathbf{e}}_1 = \mathbf{B}_t \cdot \hat{\mathbf{e}}_1 \quad (\text{B.C. on } \mathbf{B}). \quad (2.85)$$

The Amperian loops are to be used with Ampere's law (as modified)  $\oint \mathbf{H} \cdot d\mathbf{r} = \int (\mathbf{J}_f + \frac{\partial \mathbf{D}}{\partial t}) \cdot d\mathbf{S}$  and Faraday's law  $\oint \mathbf{E} \cdot d\mathbf{r} = - \int \frac{\partial \mathbf{B}}{\partial t} \cdot d\mathbf{S}$ . The Amperian loops are infinitesimally thin such that the contributions of  $\frac{\partial \mathbf{D}}{\partial t}$  and  $\frac{\partial \mathbf{B}}{\partial t}$  are negligible, and so we are only concerned with free surface

currents but in our case  $\mathbf{K}_f = 0$ . Hence,

$$(\mathbf{B}_i + \mathbf{B}_r)/\mu_i \cdot \hat{\mathbf{e}}_2 = \mathbf{B}_t/\mu_t \cdot \hat{\mathbf{e}}_2 \quad (\text{B.C. on } \mathbf{H}), \quad (2.86)$$

$$(\mathbf{B}_i + \mathbf{B}_r)/\mu_i \cdot \hat{\mathbf{e}}_3 = \mathbf{B}_t/\mu_t \cdot \hat{\mathbf{e}}_3 \quad (\text{B.C. on } \mathbf{H}), \quad (2.87)$$

$$(\mathbf{E}_i + \mathbf{E}_r) \cdot \hat{\mathbf{e}}_2 = \mathbf{E}_t \cdot \hat{\mathbf{e}}_2 \quad (\text{B.C. on } \mathbf{E}), \quad (2.88)$$

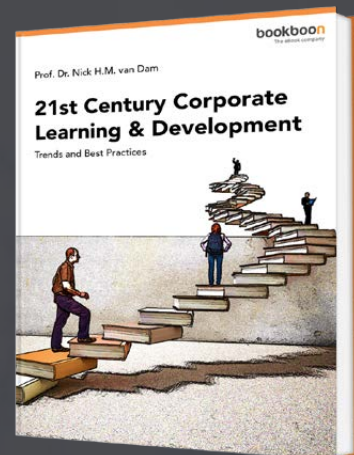
$$(\mathbf{E}_i + \mathbf{E}_r) \cdot \hat{\mathbf{e}}_3 = \mathbf{E}_t \cdot \hat{\mathbf{e}}_3 \quad (\text{B.C. on } \mathbf{E}). \quad (2.89)$$

For the equations involving the magnetic field we can substitute  $B = (n/c)E$ . Thus, for a monochromatic plane EM wave in a non-magnetic material, for which  $\mu \approx \mu_0$  such that  $\varepsilon \approx n^2\varepsilon_0$ , we have a set of six simultaneous equations for  $E_r$  and  $E_t$  to be solved in terms of the (known) amplitude the electric field of the incident wave,  $E_i$ , its angle of incidence  $\theta_i$  and the refractive indices of the two dielectrics. For the cases of polarisation perpendicular to, or parallel to, the plane of incidence, three of the six equations are identity equations leaving three equations (one of these three being redundant) which we will solve in the following sections.

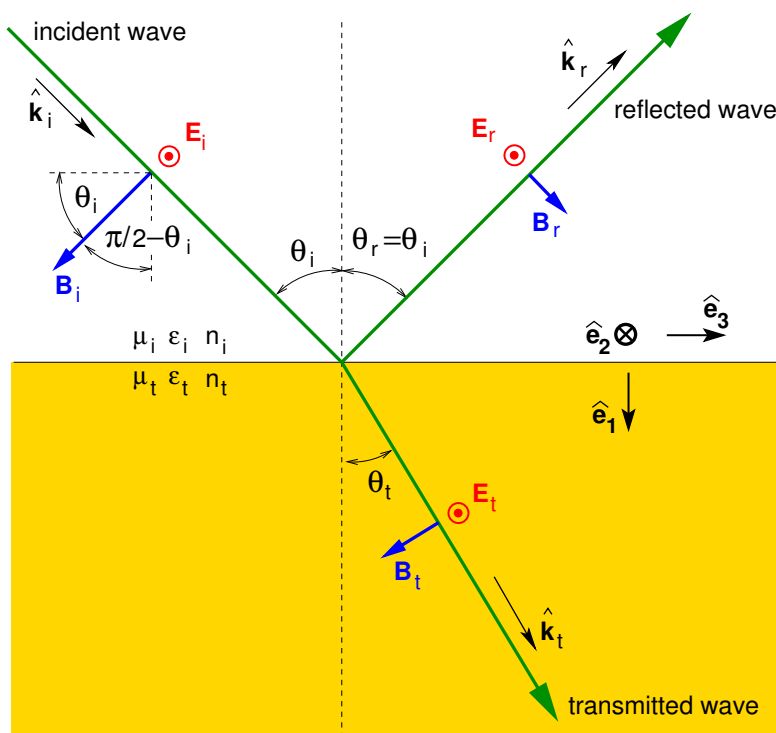
# Free eBook on Learning & Development

By the Chief Learning Officer of McKinsey

[Download Now](#)



### 2.7.2 Amplitude reflection and transmission coefficients for perpendicular polarisation



**Figure 2.17:** EM field geometry for perpendicular ( $\sigma$ ,  $s$ ) polarisation. The electric field is shown pointing out of the page.

The EM field geometry for perpendicular ( $\sigma$ ,  $s$ ) polarisation is shown in Fig. 2.17. In this case,  $\mathbf{E} \cdot \hat{\mathbf{e}}_1 = 0$ ,  $\mathbf{E} \cdot \hat{\mathbf{e}}_3 = 0$  and  $\mathbf{B} \cdot \hat{\mathbf{e}}_2 = 0$ , and so the three simultaneous equations remaining are

$$(E_i^\perp + E_r^\perp)(n_i/c) \cos(\pi/2 - \theta_i) = E_t^\perp(n_t/c) \cos(\pi/2 - \theta_t) \quad (\text{B.C. on } \mathbf{B}), \quad (2.90)$$

$$(-E_i^\perp + E_r^\perp)[n_i/(c\mu_0)] \cos \theta_i = -E_t^\perp[n_t/(c\mu_0)] \cos \theta_t \quad (\text{B.C. on } \mathbf{H}), \quad (2.91)$$

$$(E_i^\perp + E_r^\perp) = E_t^\perp \quad (\text{B.C. on } \mathbf{E}). \quad (2.92)$$

Solving simultaneous Eqs. 2.91 and 2.92 we obtain

$$E_r^\perp = \frac{\cos \theta_i - (n_t/n_i) \cos \theta_t}{\cos \theta_i + (n_t/n_i) \cos \theta_t} E_i^\perp, \quad (2.93)$$

$$E_t^\perp = \frac{2 \cos \theta_i}{\cos \theta_i + (n_t/n_i) \cos \theta_t} E_i^\perp. \quad (2.94)$$



Using Snell's law  $n_t \sin \theta_t = n_i \sin \theta_i$ , from which

$$\cos \theta_t = \sqrt{1 - n_i^2/n_t^2 \sin^2 \theta_i} \quad (2.95)$$

we arrive at the *amplitude reflection coefficient for perpendicular polarisation*,

$$r_{\perp} \equiv \frac{E_r^{\perp}}{E_i^{\perp}} = \frac{\cos \theta_i - \sqrt{(n_t/n_i)^2 - \sin^2 \theta_i}}{\cos \theta_i + \sqrt{(n_t/n_i)^2 - \sin^2 \theta_i}}, \quad (2.96)$$

and the *amplitude transmission coefficient for perpendicular polarisation*,

$$t_{\perp} \equiv \frac{E_t^{\perp}}{E_i^{\perp}} = \frac{2 \cos \theta_i}{\cos \theta_i + \sqrt{(n_t/n_i)^2 - \sin^2 \theta_i}}. \quad (2.97)$$



www.sylvania.com

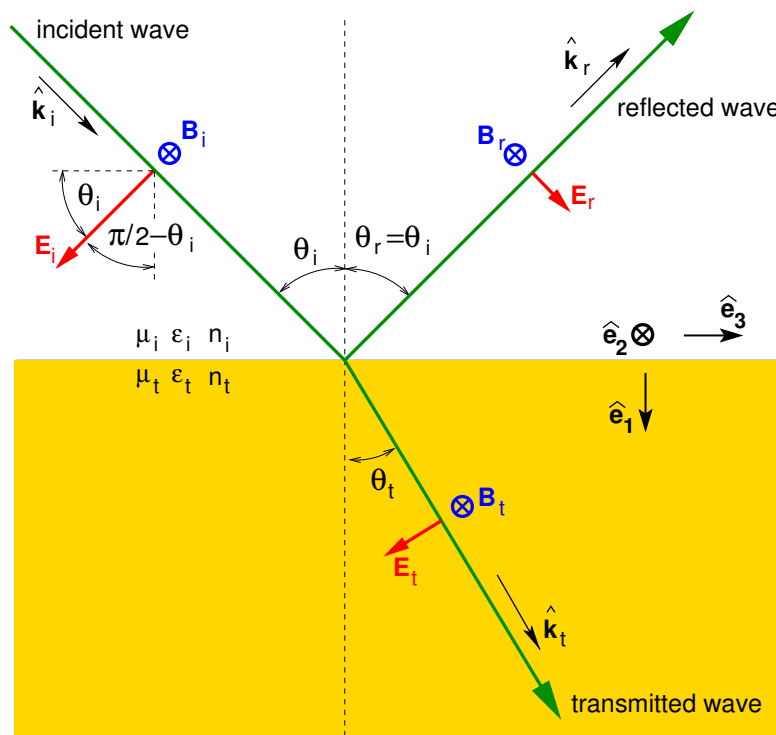
We do not reinvent the wheel we reinvent light.

Fascinating lighting offers an infinite spectrum of possibilities: Innovative technologies and new markets provide both opportunities and challenges. An environment in which your expertise is in high demand. Enjoy the supportive working atmosphere within our global group and benefit from international career paths. Implement sustainable ideas in close cooperation with other specialists and contribute to influencing our future. Come and join us in reinventing light every day.

Light is OSRAM

OSRAM SYLVANIA

## 2.7.3 Amplitude reflection and transmission coefficient for parallel polarisation



**Figure 2.18:** EM field geometry for parallel ( $\pi$ ,  $p$ ) polarisation. The magnetic field is shown pointing in to the page.

The EM field geometry for parallel ( $\pi$ ,  $p$ ) polarisation is shown in Fig. 2.18. In this case,  $\mathbf{B} \cdot \hat{\mathbf{e}}_1 = 0$ ,  $\mathbf{B} \cdot \hat{\mathbf{e}}_3 = 0$  and  $\mathbf{E} \cdot \hat{\mathbf{e}}_2 = 0$ , and so the three simultaneous equations remaining are

$$(\varepsilon_i E_i^{\parallel} + \varepsilon_i E_r^{\parallel}) \sin \theta_i = \varepsilon_t E_t^{\parallel} \sin \theta_t \quad (\text{B.C. on } \mathbf{D}), \quad (2.98)$$

$$(E_i^{\parallel} + E_r^{\parallel}) n_i = E_t^{\parallel} n_t \quad (\text{B.C. on } \mathbf{H}), \quad (2.99)$$

$$(-E_i^{\parallel} + E_r^{\parallel}) \cos \theta_i = -E_t^{\parallel} \cos \theta_t \quad (\text{B.C. on } \mathbf{E}). \quad (2.100)$$

Solving simultaneous Eqs. 2.99 and 2.100 we obtain

$$E_r^{\parallel} = \frac{(n_t/n_i) \cos \theta_i - \cos \theta_t}{(n_t/n_i) \cos \theta_i + \cos \theta_t} E_i^{\parallel}, \quad (2.101)$$

$$E_t^{\parallel} = \frac{2 \cos \theta_i}{(n_t/n_i) \cos \theta_i + \cos \theta_t} E_i^{\parallel}. \quad (2.102)$$

Using Snell's law to replace  $\theta_t$  we arrive at the *amplitude reflection coefficient for parallel polarisation*,

$$r_{\parallel} \equiv \frac{E_r^{\parallel}}{E_i^{\parallel}} = \frac{(n_t/n_i)^2 \cos \theta_i - \sqrt{(n_t/n_i)^2 - \sin^2 \theta_i}}{(n_t/n_i)^2 \cos \theta_i + \sqrt{(n_t/n_i)^2 - \sin^2 \theta_i}}, \quad (2.103)$$

and the *amplitude transmission coefficient for parallel polarisation*,

$$t_{\parallel} \equiv \frac{E_t^{\parallel}}{E_i^{\parallel}} = \frac{2 (n_t/n_i) \cos \theta_i}{(n_t/n_i)^2 \cos \theta_i + \sqrt{(n_t/n_i)^2 - \sin^2 \theta_i}}. \quad (2.104)$$

#### 2.7.4 Amplitude coefficients and phase shift for external reflection

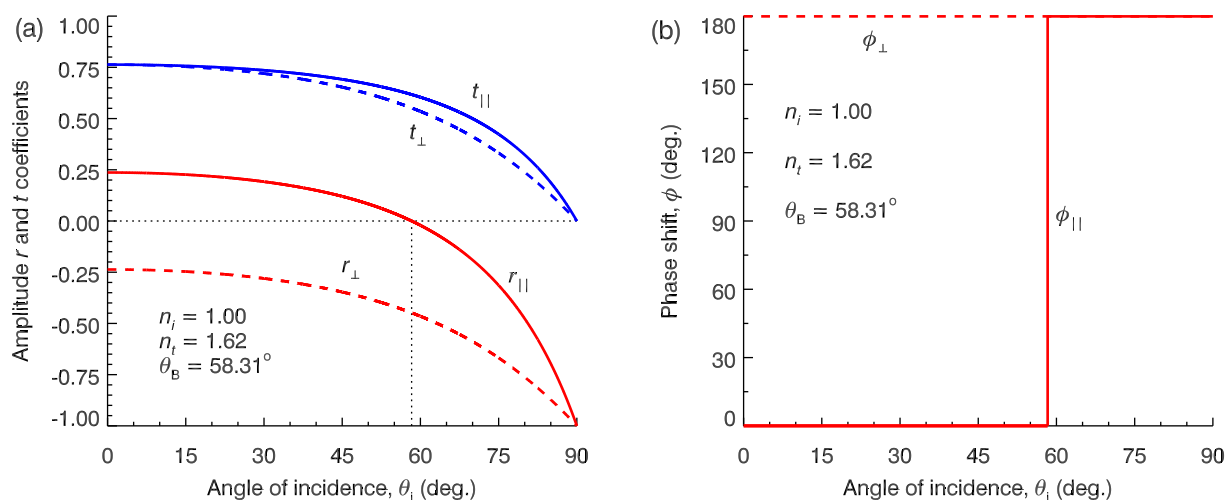
By definition, for external reflection  $n_t > n_i$ . Hence,  $\sqrt{(n_t/n_i)^2 - \sin^2 \theta_i}$  in Eqs. 2.96, 2.97, 2.103 and 2.104 is real for all  $\theta_i$ , and so therefore are  $r_{\perp}$ ,  $t_{\perp}$ ,  $r_{\parallel}$  and  $t_{\parallel}$  plotted in Fig. 2.19(a) for light incident from air ( $n_i \approx 1$ ) on to flint glass ( $n_i \approx 1.62$ ).

Notice that for the example in Fig. 2.19(a) as the angle of incidence varies from  $\theta_i = 0^\circ$  to  $90^\circ$  that the amplitude reflection coefficient for parallel polarisation changes smoothly from  $r_{\parallel} = +0.24$  to  $-1$ . The angle of incidence at which the amplitude reflection coefficient for parallel polarisation is zero is called Brewster's angle  $\theta_B$ , i.e.  $r_{\parallel}(\theta_B) = 0$ . At Brewster's angle only perpendicular polarised waves are reflected, and this is one method of producing linearly polarised light. We may obtain Brewster's angle by setting  $r_{\parallel} = 0$  in Eq. 2.103 to obtain

$$\cos \theta_B = \frac{1}{\sqrt{1 + (n_t/n_i)^2}}, \quad (2.105)$$

$$\tan \theta_B = \frac{n_t}{n_i}. \quad (2.106)$$

The amplitude reflection coefficients are in general complex, but in the case of external reflection,  $r_{\parallel}$  and  $r_{\perp}$  are real for all  $\theta_i$ . If  $r \geq 0$  the phase shift is zero, but if  $r < 0$  there is a phase shift on reflection by  $\pi$  radians ( $180^\circ$ ) since  $e^{\pm i\pi} = -1$ . This is illustrated in Fig. 2.19(b).



**Figure 2.19:** Amplitude reflection and transmission coefficients (a) and phase shift (b) for external reflection off flint glass.

### 2.7.5 Amplitude coefficients and phase shift for internal reflection

The amplitude coefficients for the case of internal reflection  $r_{\perp}$ ,  $t_{\perp}$ ,  $r_{\parallel}$  and  $t_{\parallel}$  are plotted in Fig. 2.20(a) for flint glass to air. There is a critical angle of incidence  $\theta_c$  such that if  $\theta_i > \theta_c$  Snell's law cannot be satisfied as  $\sin \theta_t$  would need to exceed 1. For  $\theta_i > \theta_c$  there will be no transmission,  $t = 0$ , but there will be *total internal reflection*,  $|r| = 1$ . From Snell's law with  $\theta_t = 90^\circ$  the critical angle is

$$\theta_c = \sin^{-1} \left( \frac{n_t}{n_i} \right). \quad (2.107)$$

For internal reflection  $n_t < n_i$ , and so  $\sqrt{(n_t/n_i)^2 - \sin^2 \theta_i}$  in Eqs. 2.96–2.104 is either real if  $\theta_i < \theta_c$  or imaginary if  $\theta_i > \theta_c$ . Hence, for  $\theta_i < \theta_c$  the amplitude reflection coefficients are real, and so the phase shift is  $\phi = 0^\circ$  if  $r > 0$  and  $\phi = 180^\circ$  if  $r < 0$ , as was the case for external reflection. However, for  $\theta_i > \theta_c$  the amplitude reflection coefficients are complex, and what is plotted in Fig. 2.20(b) for  $\theta_i > \theta_c$  is actually  $|r_{\perp}|$  and  $|r_{\parallel}|$ .

Adopting the convention used in optics texts for the sign of  $\phi$  (e.g. Pedrotti & Pedrotti, 2nd Ed., p. 414) the amplitude reflection coefficient is defined  $r = |r|e^{-i\phi}$ . The phase shift  $\phi$  may

then be derived by noting that for  $\theta_i > \theta_c$  Eqs. 2.96 and 2.103 may be written in the form

$$r = \frac{a - ib}{a + ib} = \frac{\sqrt{a^2 + b^2} e^{-i\psi}}{\sqrt{a^2 + b^2} e^{+i\psi}} = e^{-2i\psi} = e^{-i\phi} \quad (2.108)$$

and so the phase shift is

$$\phi = 2 \tan^{-1} \left( \frac{b}{a} \right) \quad (2.109)$$

where  $b = \sqrt{\sin^2 \theta_i - (n_t/n_i)^2}$ , and for perpendicular polarisation  $a = \cos \theta_i$  and for parallel polarisation  $a = (n_t/n_i)^2 \cos \theta_i$ . The resulting phase shifts are plotted in Fig. 2.20(b).



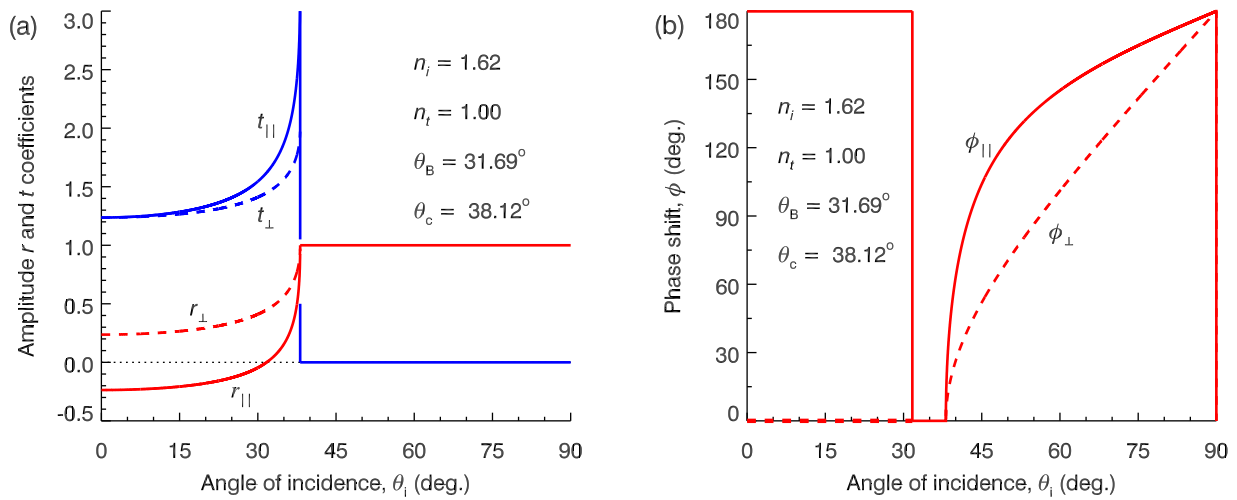
Discover the truth at [www.deloitte.ca/careers](http://www.deloitte.ca/careers)

**Deloitte.**

© Deloitte & Touche LLP and affiliated entities.



Click on the ad to read more



**Figure 2.20:** (a) Amplitude reflection and transmission coefficients, and (b) phase shift, for internal reflection within flint glass. (For  $\theta_i > \theta_c$  in part (a)  $|r_{\perp}|$  and  $|r_{\parallel}|$  is plotted.)

### 2.7.6 Normal incidence

For normal incidence the plane of incidence is undefined and the results we have obtained for the cases of parallel and perpendicular polarisations must therefore become identical as  $\theta_i \rightarrow 0$ . For perpendicular polarisation the amplitude coefficients (Eqs. 2.96 and 2.97) for normal incidence are

$$r_{\perp}(0^\circ) = \frac{1 - n_t/n_i}{1 + n_t/n_i}, \quad t_{\perp}(0^\circ) = \frac{2}{1 + n_t/n_i}. \quad (2.110)$$

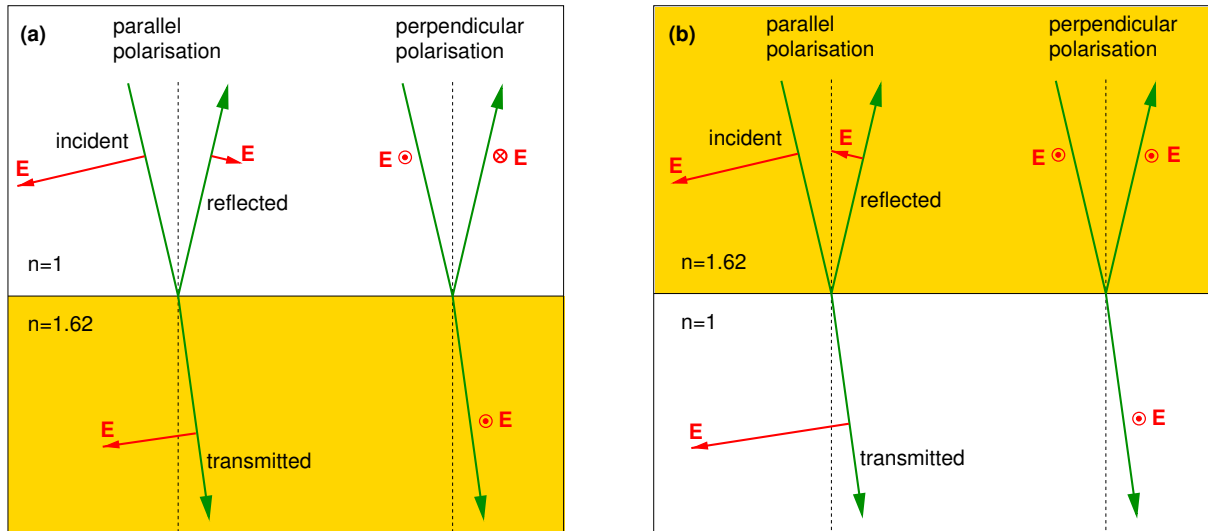
whereas for parallel polarisation Eqs. 2.103 and 2.104 become

$$r_{\parallel}(0^\circ) = \frac{n_t/n_i - 1}{n_t/n_i + 1}, \quad t_{\parallel}(0^\circ) = \frac{2}{n_t/n_i + 1}. \quad (2.111)$$

From Eqs. 2.110 and 2.111 (and  $\theta_i = 0^\circ$  in Figs. 2.19 and 2.20) we see that  $r_{\parallel}(0^\circ) = -r_{\perp}(0^\circ)$ , but for normal incidence perpendicular and parallel polarisations should be identical!

So what is going on? To understand, we must remember that these coefficients and phase shifts are defined relative to the electric field directions of the incident, reflected and transmitted

waves given in Figs. 2.17 and 2.18. When these amplitude reflection coefficients are applied to the electric fields of the reflected and transmitted waves in Figs. 2.17 and 2.18 for a small angle of incidence the fields are as in Fig. 2.21.



**Figure 2.21:** Electric field directions for near-normal incidence for (a) external reflection off flint glass and (b) internal reflection within flint glass.

For external reflection (Fig. 2.21a) at normal incidence the electric field direction of the reflected wave is opposite to that of the incident wave, whereas for internal reflection (Fig. 2.21b) the electric field direction is in the same direction as that of the incident wave. Hence, for reflection at normal incidence there is a phase shift of  $180^\circ$  on reflection for external reflection, but no phase shift for internal reflection irrespective of polarisation.

### 2.7.7 Reflectance and transmittance

The reflectance and transmittance are defined in terms of the rate of energy flow incident on unit area of the interface,  $\mathbf{S}_i \cdot (-\hat{\mathbf{e}}_1) = S_i \cos \theta_i$ . Thus the reflectance and transmittance are

$$R = \frac{S_r \cos \theta_r}{S_i \cos \theta_i}, \quad T = \frac{S_t \cos \theta_t}{S_i \cos \theta_i}, \quad (2.112)$$

where

$$S = \varepsilon E^2 v_p \approx (n^2 \varepsilon_0) E^2 (c/n) \quad (2.113)$$

is the magnitude of the Poynting vector, and the  $\cos\theta$  factors take account of the projected area of the interface as seen by the incoming and outgoing waves. Hence

$$R = |r|^2; \quad T = \frac{n_t \cos\theta_t}{n_i \cos\theta_i} t^2 = 1 - R. \quad (2.114)$$

For the case of internal reflection (Fig. 2.20) we see that as  $\theta_i \rightarrow \theta_c$  both amplitude reflection coefficients obey  $r \rightarrow 1$ , while the amplitude transmission coefficients remain finite. However, because  $\cos\theta_t \rightarrow 0$  as  $\theta_i \rightarrow \theta_c$  while  $\cos\theta_i \rightarrow \cos\theta_c$  which is finite, from Eq.2.114 we must have  $T \rightarrow 0$  as  $\theta_i \rightarrow \theta_c$ . It is straightforward to show that  $R + T = 1$ , as required by energy conservation. The reflectance is shown in Fig. 2.22 for the cases of (a) external reflection and (b) internal reflection.

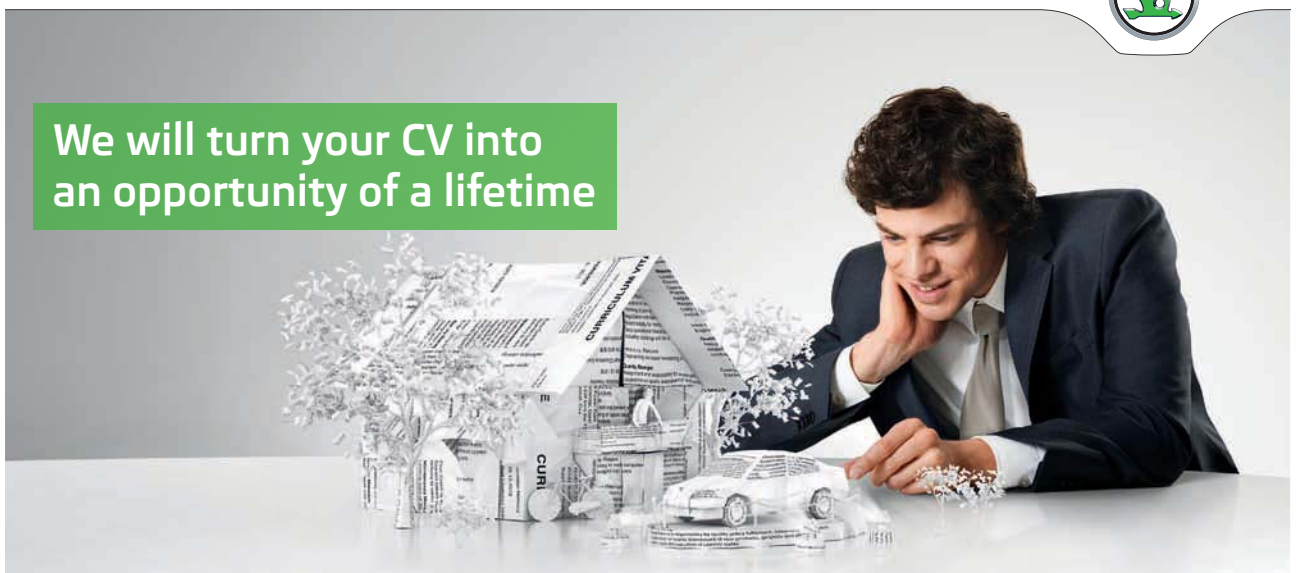
Notice that for the case of external reflection shown in Fig. 2.22(a) and *grazing incidence*, i.e..  $\theta_i \rightarrow 90^\circ$ , the reflectance approaches 100% ( $R \rightarrow 1$ ). This phenomenon is used in the design of imaging X-ray space telescopes, and a typical design based on XMM-Newton is sketched in Fig.2.23

SIMPLY CLEVER

ŠKODA



We will turn your CV into  
an opportunity of a lifetime



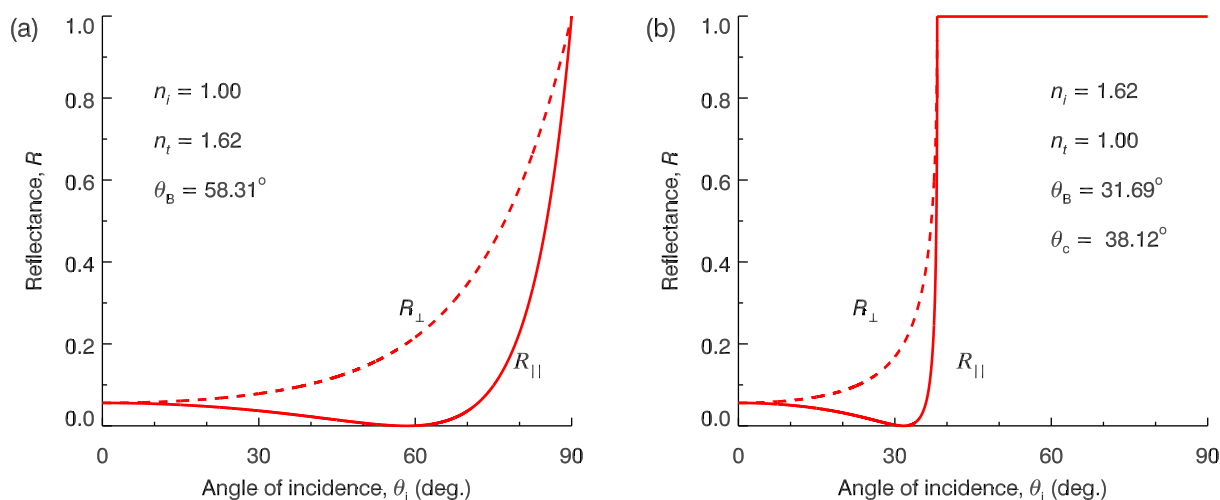
Do you like cars? Would you like to be a part of a successful brand?  
We will appreciate and reward both your enthusiasm and talent.  
Send us your CV. You will be surprised where it can take you.

Send us your CV on  
[www.employerforlife.com](http://www.employerforlife.com)



Click on the ad to read more





**Figure 2.22:** Reflectance for (a) external reflection off flint glass and (b) internal reflection within flint glass.

### 2.7.8 Evanescent waves and frustrated total internal reflection

When  $\theta_i > \theta_c$  we have total internal reflection, but there must still be an EM field present on the other side of the interface to satisfy the boundary conditions. This transmitted EM wave will have wave vector

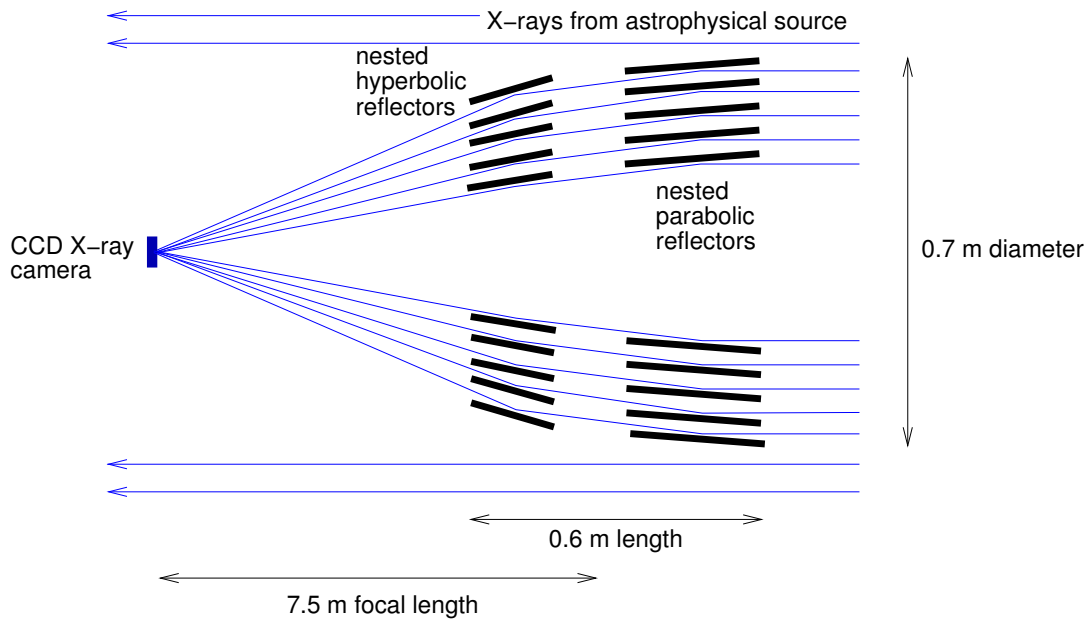
$$\mathbf{k}_t = \frac{\omega n_t}{c} (\sin \theta_t \hat{\mathbf{e}}_3 + \cos \theta_t \hat{\mathbf{e}}_1). \quad (2.115)$$

For  $\theta_i > \theta_c$ , Snell's law (derived from the boundary conditions) gives an imaginary value for  $\cos \theta_t$

$$\cos \theta_t = \sqrt{1 - \sin^2 \theta_t} = \sqrt{1 - \left(\frac{n_t}{n_i}\right)^2 \sin^2 \theta_i} = \pm i \sqrt{\left(\frac{n_t}{n_i}\right)^2 \sin^2 \theta_i - 1}. \quad (2.116)$$

Also from Snell's law we have  $\sin \theta_t = (n_i/n_t) \sin \theta_i$ , so

$$\mathbf{k}_t = \frac{\omega n_t}{c} \left( \frac{n_i}{n_t} \sin \theta_i \hat{\mathbf{e}}_3 \pm i \sqrt{\left(\frac{n_t}{n_i}\right)^2 \sin^2 \theta_i - 1} \hat{\mathbf{e}}_1 \right) \quad (2.117)$$



**Figure 2.23:** Cross-section through an imaging X-ray telescope (not to scale). Dimensions given are for the XMM-Newton X-ray telescope for which the 58 concentric mirrors are made of nickel coated with gold and are separated by 1–5 mm.

Hence the transmitted EM wave is

$$\mathbf{E}_t = \mathcal{E}_t \exp\{i(\mathbf{k}_t \cdot \mathbf{r} - \omega t)\}, \quad (2.118)$$

$$= \mathcal{E}_t \exp \left\{ i \left[ \frac{\omega n_t}{c} \left( \frac{n_i}{n_t} \sin \theta_i \hat{\mathbf{e}}_3 \pm i \sqrt{\left( \frac{n_t}{n_i} \right)^2 \sin^2 \theta_i - 1} \hat{\mathbf{e}}_1 \right) \cdot \mathbf{r} - \omega t \right] \right\}, \quad (2.119)$$

$$= \mathcal{E}_t \exp \left\{ i \left[ \frac{\omega n_t}{c} \left( \frac{n_i}{n_t} \sin \theta_i \right) \hat{\mathbf{e}}_3 \cdot \mathbf{r} - \omega t \right] \right\} \\ \times \exp \left( - \frac{\omega n_t}{c} \sqrt{\left( \frac{n_t}{n_i} \right)^2 \sin^2 \theta_i - 1} \hat{\mathbf{e}}_1 \cdot \mathbf{r} \right), \quad (2.120)$$

and we see that we have a wave propagating in the  $\hat{\mathbf{e}}_3$  direction (i.e. parallel to the surface) and so is a surface wave. However, the wave is decaying exponentially in the  $\hat{\mathbf{e}}_1$  direction, i.e. with distance away from the surface of the dielectric. Such a surface wave is called an *evanescent wave*. Examining Eq. 2.120 we see that the decay distance for the electric field is  $\sim c/\omega$ , or of the order of magnitude of the wavelength, and that the wave cannot propagate into the region away from the dielectric as a monochromatic plane wave.

Evanescent waves may cross a small gap (as in quantum tunnelling) if a slab of similar dielectric

is brought within a few wavelengths of the dielectric in which the wave is incident. In that case part of the incident wave tunnels through the gap and propagates in the slab as a monochromatic plane wave in the same direction as the original incident wave, but with reduced intensity depending on the width of the gap. This “frustrated total internal reflection” has practical applications in optics with beam-splitters and optical fibre junctions.

## Summary of important concepts and equations

### 1D wave equation

$$\frac{\partial^2 f}{\partial x^2} = \frac{1}{v^2} \frac{\partial^2 f}{\partial t^2} \quad \text{has general solution} \quad f(x, t) = \psi_+(x - vt) + \psi_-(x + vt)$$

- $\psi_+$  moves in  $+x$  direction
- $\psi_-$  moves in  $-x$  direction
- wave speed  $v$



**e-learning for kids**

- The number 1 MOOC for Primary Education
- Free Digital Learning for Children 5-12
- 15 Million Children Reached

**About e-Learning for Kids** Established in 2004, e-Learning for Kids is a global nonprofit foundation dedicated to fun and free learning on the Internet for children ages 5 - 12 with courses in math, science, language arts, computers, health and environmental skills. Since 2005, more than 15 million children in over 190 countries have benefitted from eLessons provided by EFK! An all-volunteer staff consists of education and e-learning experts and business professionals from around the world committed to making difference. eLearning for Kids is actively seeking funding, volunteers, sponsors and courseware developers; get involved! For more information, please visit [www.e-learningforkids.org](http://www.e-learningforkids.org).

**Sinusoidal wave travelling in  $+x$  direction**

- $f(x, t) = f_0 \cos(kx - \omega t + \delta)$
- wavelength  $\lambda = 2\pi/k$
- wave number  $k = 2\pi/\lambda$
- frequency  $\nu = v/\lambda$
- phase  $[k(x - vt) + \delta]$
- phase constant  $\delta$
- angular frequency  $\omega = vk = 2\pi\nu$
- $v$  above is actually the phase velocity  $v_p = \omega/k$

**Complex form of sinusoidal wave**

- $f(x, t) = \operatorname{Re} \left\{ f_0 e^{i(kx - \omega t)} \right\} = |f_0| \operatorname{Re} \left\{ e^{i(kx - \omega t + \delta)} \right\} = |f_0| \cos(kx - \omega t + \delta)$
- $f_0 = |f_0| e^{i\delta}$  is a complex amplitude.

**3D wave equation**

- $\nabla^2 f = \frac{1}{v^2} \frac{\partial^2 f}{\partial t^2}$
- monochromatic plane wave solutions  $f(\mathbf{r}, t) = f_0 \exp[i(\mathbf{k} \cdot \mathbf{r} - \omega t)]$
- $\mathbf{k} = k \hat{\mathbf{k}}$  is the wave vector

**Lossless transmission lines**

- two parallel conductors of uniform cross section separated by an insulator (permittivity  $\varepsilon$ , permeability  $\mu$ ) and designed to carry radio frequency signals
- for inductance per unit length  $L$  and capacitance per unit length  $C$ , the wave equations are

$$\frac{\partial^2 V(x, t)}{\partial x^2} - LC \frac{\partial^2 V(x, t)}{\partial t^2} = 0, \quad \frac{\partial^2 I(x, t)}{\partial x^2} - LC \frac{\partial^2 I(x, t)}{\partial t^2} = 0$$

- characteristic impedance  $Z = \sqrt{L/C}$  and phase velocity  $v_p = 1/\sqrt{LC} = 1/\sqrt{\mu\varepsilon}$

### Wave equation for EM waves in linear medium

- $\nabla^2 \mathbf{E} - \mu\varepsilon \frac{\partial^2 \mathbf{E}}{\partial t^2} = 0$

- phase velocity of EM waves  $v_p = 1/\sqrt{\mu\varepsilon}$ ;  $c = 1/\sqrt{\mu_0\varepsilon_0} \equiv 299792458$  m/s

- wave impedance of the medium  $Z = \sqrt{\varepsilon/\mu}$ ,  $Z_0 \equiv \sqrt{\mu_0/\varepsilon_0} \approx 377 \Omega$

- EM fields:

$$\begin{aligned} \mathbf{E}(\mathbf{r}, t) &= \mathbf{E}_0 \exp[i(\mathbf{k} \cdot \mathbf{r} - \omega t)], & \mathbf{B}(\mathbf{r}, t) &= \omega^{-1} \mathbf{k} \times \mathbf{E}(\mathbf{r}, t), \\ B(\mathbf{r}, t) &= \frac{1}{v_p} E(\mathbf{r}, t), & H(\mathbf{r}, t) &= \frac{1}{Z} E(\mathbf{r}, t), \end{aligned}$$

subject to  $\mathbf{k} \cdot \mathbf{E}_0 = 0$

- energy density  $u(\mathbf{r}, t) = \varepsilon E_0^2 \cos^2(\mathbf{k} \cdot \mathbf{r} - \omega t + \delta)$

- Poynting vector  $\mathbf{S} = v_p \varepsilon E^2 \hat{\mathbf{k}}$

- intensity  $I = v_p \varepsilon |E_0|^2 / 2$

### Polarisation

- Linear polarisation

$$\mathbf{E} = (\hat{\mathbf{x}}E_{0,x} + \hat{\mathbf{y}}E_{0,y}) \cos(kz - \omega t + \delta)$$

- Circular polarisation

$$\mathbf{E} = E_0 [\hat{\mathbf{x}} \cos(kz - \omega t + \delta_x) + \hat{\mathbf{y}} \sin(kz - \omega t + \delta_x)] \quad (\text{right})$$

$$\mathbf{E} = E_0 [\hat{\mathbf{x}} \cos(kz - \omega t + \delta_x) - \hat{\mathbf{y}} \sin(kz - \omega t + \delta_x)] \quad (\text{left})$$

### Reflection and refraction

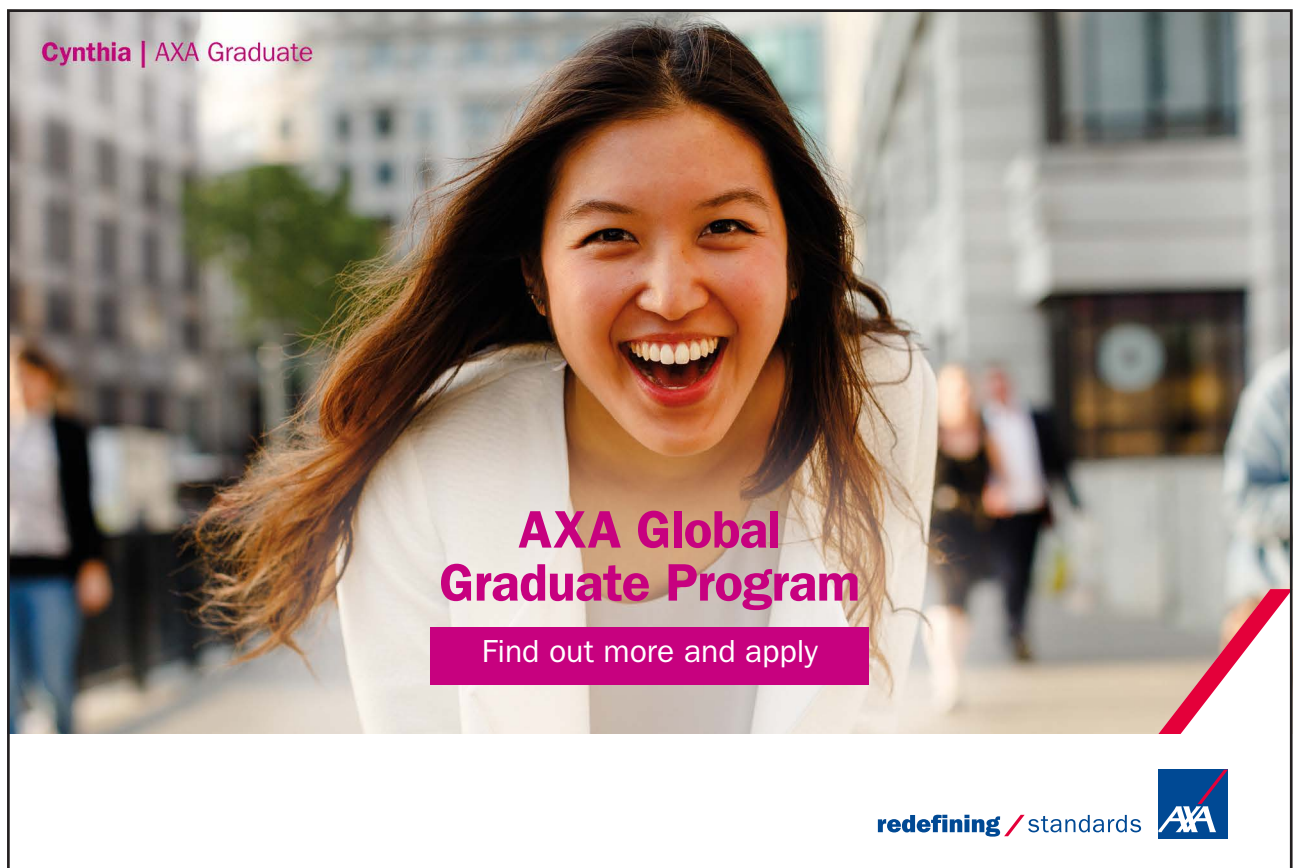
- plane of incidence contains incident ( $i$ ) ray, normal to interface, reflected ( $r$ ) and transmitted ( $t$ ) rays

- law of reflection  $\theta_i = \theta_r$
- refractive index of medium containing incident wave  $n_i$
- refractive index of medium containing transmitted wave  $n_t$
- Snell's law  $n_i \sin \theta_i = n_t \sin \theta_t$
- amplitude reflection and transmission coefficients depend on polarisation
- parallel polarisation has  $\mathbf{E}$  parallel to plane of incidence
- perpendicular polarisation has  $\mathbf{E}$  perpendicular to plane of incidence

### Fresnel equations

- amplitude reflection and transmission coefficients


$$r_{\perp} \equiv \frac{E_r^{\perp}}{E_i^{\perp}} = \frac{\cos \theta_i - \sqrt{(n_t/n_i)^2 - \sin^2 \theta_i}}{\cos \theta_i + \sqrt{(n_t/n_i)^2 - \sin^2 \theta_i}}$$



**Cynthia | AXA Graduate**

**AXA Global Graduate Program**

Find out more and apply

redefining / standards 

$$t_{\perp} \equiv \frac{E_t^{\perp}}{E_i^{\perp}} = \frac{2 \cos \theta_i}{\cos \theta_i + \sqrt{(n_t/n_i)^2 - \sin^2 \theta_i}}$$

$$r_{\parallel} \equiv \frac{E_r^{\parallel}}{E_i^{\parallel}} = \frac{(n_t/n_i)^2 \cos \theta_i - \sqrt{(n_t/n_i)^2 - \sin^2 \theta_i}}{(n_t/n_i)^2 \cos \theta_i + \sqrt{(n_t/n_i)^2 - \sin^2 \theta_i}}$$

$$t_{\parallel} \equiv \frac{E_t^{\parallel}}{E_i^{\parallel}} = \frac{2 (n_t/n_i) \cos \theta_i}{(n_t/n_i)^2 \cos \theta_i + \sqrt{(n_t/n_i)^2 - \sin^2 \theta_i}}$$

- reflectance and transmittance  $R = |r|^2$  and  $T = 1 - R$
- Brewster's angle  $r_{\parallel}(\theta_B) = 0$ : only  $\perp$  polarisation reflected,  $\tan \theta_B = n_t/n_i$
- total internal reflection for  $\theta_i > \theta_c$  where  $\sin \theta_c = n_t/n_i$

### Normal incidence

- for external reflection the electric field direction of the reflected wave is opposite to the electric field direction of the incident wave ( $180^\circ$  phase shift)
- for internal reflection the direction of the electric field of the reflected wave is the same as that of the electric field of the incident wave (no phase shift)

### Exercises on Chapter 2

2-1 Prove that the spherical waves given by

$$f(\mathbf{r}, t) = f_0 r^{-1} \exp[i(\pm kr - \omega t)] \quad (2.121)$$

are solutions of the 3D wave equation.

2-2 A monochromatic plane wave  $\mathbf{E}(\mathbf{r}, t) = \mathbf{E}_0 \exp[i(\mathbf{k} \cdot \mathbf{r} - \omega t)]$  is travelling in the  $+\hat{\mathbf{z}}$  direction through a lossless linear medium with relative permittivity  $\epsilon_r = 4$  and relative permeability  $\mu_r \approx 1$  and is polarised in the  $\hat{\mathbf{x}}$  direction. The frequency is  $\nu = 1$  GHz and  $E$  has a maximum value of  $+10^{-3}$  V/m at  $t = 5$  ns and  $z = 1$  m.

(a) Find the angular frequency, phase velocity, wavenumber, wave vector, and wavelength.

- (b) Obtain the instantaneous expression for  $\mathbf{E}(\mathbf{r}, t)$  valid for any position and time.  
 (c) Obtain the instantaneous expression for  $\mathbf{H}(\mathbf{r}, t)$  valid for any position and time.  
 (d) Find the Poynting vector and its time-averaged value.  
 (e) Find the locations where  $E_x$  is maximum when  $t = 0$  s.

2–3 Given the electric fields for the following polarisations,

$$\mathbf{E}(\mathbf{r}, t) = (\hat{\mathbf{x}}E_{0,x} + \hat{\mathbf{y}}E_{0,y}) \cos(kz - \omega t + \delta) \quad (\text{linear}), \quad (2.122)$$

$$\mathbf{E}(\mathbf{r}, t) = E_0[\hat{\mathbf{x}} \cos(kz - \omega t + \delta_x) - \hat{\mathbf{y}} \sin(kz - \omega t + \delta_x)] \quad (\text{left circular}), \quad (2.123)$$

$$\mathbf{E}(\mathbf{r}, t) = \hat{\mathbf{x}}E_{0,x} \cos(kz - \omega t + \delta_x) + \hat{\mathbf{y}}E_{0,y} \sin(kz - \omega t + \delta_x) \quad (\text{right elliptical}) \quad (2.124)$$

with  $E_{0,y} > E_{0,x}$ , find the instantaneous and time-averaged energy densities and Poynting vectors. In each case, assume the wave is propagating in a medium with permittivity  $\varepsilon$  and permeability  $\mu$ .

2–4 For a monochromatic EM plane wave incident on a plane interface between two dielectrics describe what is meant by perpendicular ( $\sigma$ ,  $s$ ) and parallel ( $\pi$ ,  $p$ ) polarisation states. Include a suitable diagram in your answer.

2–5 Define what is meant by the amplitude reflection and transmission coefficients, and by the reflectance and transmittance.

2–6 (a) Use the amplitude reflection coefficient for parallel polarisation

$$r_{\parallel}(\theta_i) \equiv \frac{E_r^{\parallel}}{E_i^{\parallel}} = \frac{(n_t/n_i)^2 \cos \theta_i - \sqrt{(n_t/n_i)^2 - \sin^2 \theta_i}}{(n_t/n_i)^2 \cos \theta_i + \sqrt{(n_t/n_i)^2 - \sin^2 \theta_i}}. \quad (2.125)$$

to show that Brewster's angle is given by both

$$\cos \theta_B = \frac{1}{\sqrt{1 + (n_t/n_i)^2}} \quad \text{and} \quad \tan \theta_B = \frac{n_t}{n_i}. \quad (2.126)$$

(b) Show that

$$\tan \theta_B = \frac{n_t}{n_i} \quad (2.127)$$

can also be derived from Snell's law and by requiring the angle between the reflected and transmitted rays to be  $\pi/2$ .



- 2–7 Give a formula with explanations for the reflectance and transmittance in terms of the magnitude of the Poynting vectors of the various waves, and their angles with respect to the normal to the interface. How is the reflectance related to the amplitude reflection coefficient? How is the transmittance related to the reflectance? Why?
- 2–8 Explain the physical meaning of the critical angle, and derive its formula.

I joined MITAS because  
I wanted **real responsibility**

The Graduate Programme  
for Engineers and Geoscientists  
[www.discovermitas.com](http://www.discovermitas.com)



**Month 16**

I was a construction  
supervisor in  
the North Sea  
advising and  
helping foremen  
solve problems

Real work  
International opportunities  
Three work placements



 **MAERSK**

### 3 Electromagnetic waves in dispersive media

#### Learning objectives

- To understand that if the wavenumber is complex the imaginary part leads to absorption, such that the intensity is  $I = I_0 e^{-\alpha \hat{\mathbf{k}} \cdot \mathbf{r}}$ , with absorption coefficient  $\alpha = 2 \times \text{Im}\{k(\omega)\}$ .
- To learn that in the Lorentz oscillator model of a dielectric, for  $j$  oscillators with natural frequencies  $\omega_j$  and damping coefficients  $\gamma_j$ , and on average  $f_j$  electrons with natural frequency  $\omega_j$  per atom, and  $N$  atoms per unit volume, the refractive index is
 
$$n(\omega) \approx \left( 1 + \frac{Ne^2}{\epsilon_0 m_e} \sum_j \frac{f_j}{\omega_j^2 - \omega^2 - i\gamma_j \omega} \right)^{1/2}.$$
- To know that the absorption coefficient near a resonance has a Lorentzian profile
 
$$L(\omega) = \frac{1}{\pi} \frac{(\gamma_j/2)}{(\omega_j - \omega)^2 + (\gamma_j/2)^2}.$$
- To know that in a medium the phase propagates at the phase velocity  $v_p(\omega) \equiv \frac{\omega}{k} \Big|_{\omega}$ , wave packets travel at the group velocity  $v_g(\omega) \equiv \frac{d\omega}{dk} \Big|_{\omega}$ , information and energy travel at  $v_g$ , and that if  $(d\text{Re}\{n\}/d\omega) < 0$  (anomalous dispersion) the group velocity can exceed  $c$ , but that anomalous dispersion is accompanied by absorption such that causality is not violated.
- To be able to derive the wave equation of a good conductor, use it to obtain the dispersion relation, skin depth  $\delta(\omega)$  and absorption coefficient  $\alpha(\omega) = 2/\delta(\omega)$ .
- To be able to derive the wave equation for a dilute plasma, the dispersion relation, plasma frequency, show that EM waves cannot propagate below the plasma frequency, and know that at frequencies above the highest resonant frequency a dielectric behaves like a dilute plasma.
- to learn that in a magnetised plasma or dielectric, left and right circularly polarised waves travel at different phase velocities causing the plane of polarisation to rotate (Faraday rotation).

### 3.1 Dispersion and absorption

In general, the refractive index  $n(\omega)$  is complex, as is the wave number  $k(\omega) = n(\omega)/c$ . Hence, for a monochromatic plane wave in matter

$$\mathbf{E}(\mathbf{r}, t) = \mathbf{E}_0 \exp [i(\mathbf{k} \cdot \mathbf{r} - \omega t)] \quad (3.1)$$

$$= \mathbf{E}_0 \exp \left[ i \left( \text{Re}\{k\} \hat{\mathbf{k}} \cdot \mathbf{r} - \omega t \right) \right] \exp \left( -\text{Im}\{k\} \hat{\mathbf{k}} \cdot \mathbf{r} \right). \quad (3.2)$$

This means that the intensity  $I(\mathbf{r}) = \langle S(\mathbf{r}, t) \rangle \propto \langle [E(\mathbf{r}, t)]^2 \rangle$  decays exponentially with distance,  $I(\mathbf{r}) = E_0^2 \exp \left[ -\alpha(\omega) \hat{\mathbf{k}} \cdot \mathbf{r} \right]$ , where  $\alpha(\omega) = 2 \times \text{Im}\{k(\omega)\}$  is the *absorption coefficient*.

#### 3.1.1 Lorentz oscillator model of dielectrics

The molecular polarisability of atoms can be approximated by modelling the atom semi-classically as a nucleus of effective charge  $+e$  surrounded by a spherical electron “cloud” of radius  $a_0 \approx 10^{-10}$  m corresponding to a single valence electron (charge  $-e$ ). The justification being that the nucleus is screened by all but one of the electrons, and therefore has effective charge  $+e$ .

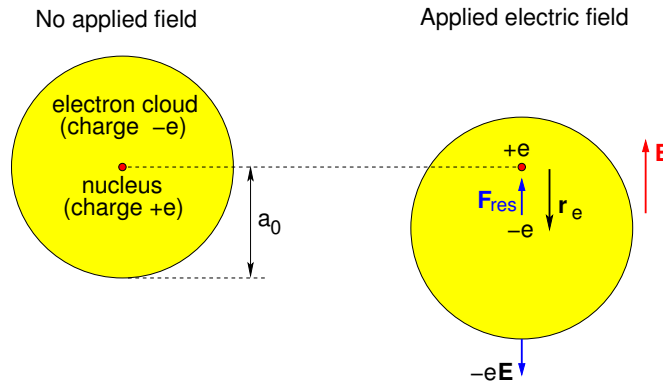
When an electric field is applied, the electron cloud becomes displaced by  $\mathbf{r}_e$  with respect to the nucleus and experiences a restoring force  $-\kappa \mathbf{r}_e$ , where  $\kappa \approx e^2/4\pi\epsilon_0 a_0^3$  is the “spring constant” (see Fig. 3.1, and Chapter 4 of “Essential Electromagnetism”). The net force on the valence electron is

$$m_e \frac{d^2 \mathbf{r}_e}{dt^2} = -e\mathbf{E} - \kappa \mathbf{r}_e, \quad (3.3)$$

and in electrostatics, we set the net force to zero to find equilibrium displacement  $\mathbf{r}_e = -e\mathbf{E}/\kappa$ , dipole moment  $\mathbf{p} = e^2 \mathbf{E}/\kappa$  and molecular polarisability  $\alpha_{\text{pol}} = e^2/\kappa = 4\pi\epsilon_0 a_0^3$ .

In electrodynamics,  $\mathbf{E} = \mathbf{E}(t)$  oscillates, and the electrons oscillate in response. Because of various drag forces analogous to friction, we must add a “damping term” which is proportional to velocity,

$$m_e \frac{d^2 \mathbf{r}_e}{dt^2} = -e\mathbf{E}(t) - \kappa \mathbf{r}_e - m_e \gamma \frac{d\mathbf{r}_e}{dt}. \quad (3.4)$$



**Figure 3.1:** Semi-classical model of an atom, without and with an applied electric field (displacement greatly exaggerated).

The resonant frequency of simple harmonic oscillation for the valence electrons in our crude model of atoms is

$$\omega_0 = \sqrt{\frac{\kappa}{m_e}} \approx \sqrt{\frac{e^2}{4\pi\epsilon_0 a_0^3 m_e}} \sim 2 \times 10^{16} \text{ rad s}^{-1} \tag{3.5}$$



# 93%

OF MIM STUDENTS ARE  
WORKING IN THEIR SECTOR 3 MONTHS  
FOLLOWING GRADUATION

---

## MASTER IN MANAGEMENT

---

- STUDY IN THE CENTER OF MADRID AND TAKE ADVANTAGE OF THE UNIQUE OPPORTUNITIES THAT THE CAPITAL OF SPAIN OFFERS
- PROPEL YOUR EDUCATION BY EARNING A DOUBLE DEGREE THAT BEST SUITS YOUR PROFESSIONAL GOALS
- STUDY A SEMESTER ABROAD AND BECOME A GLOBAL CITIZEN WITH THE BEYOND BORDERS EXPERIENCE

Length: 10 MONTHS

Av. Experience: 1 YEAR

Language: ENGLISH / SPANISH

Format: FULL-TIME

Intakes: SEPT / FEB

---

**5 SPECIALIZATIONS**  
PERSONALIZE YOUR PROGRAM

**#10 WORLDWIDE**  
MASTER IN MANAGEMENT  
FINANCIAL TIMES

**55 NATIONALITIES**  
IN CLASS

www.ie.edu/master-management
| mim.admissions@ie.edu
| Follow us on IE MIM Experience



which corresponds to frequencies in the ultraviolet. If a monochromatic plane wave (photons) with frequency close to  $\omega_0$  were incident on the atom, the work done against the friction-type forces to allow the atom oscillate would cause strong absorption of photons. In reality an atom is not a classical system with only one resonance, but rather a quantum system with many resonant frequencies. Nevertheless we can use this semi-classical model to describe the essential dielectric properties of materials.

The equation of motion of the electron is

$$m_e \frac{d^2 \mathbf{r}_e}{dt^2} = -e\mathbf{E}(t) - m_e \omega_0^2 \mathbf{r}_e - m_e \gamma \frac{d\mathbf{r}_e}{dt}, \quad (3.6)$$

$$\therefore m_e \left[ \frac{d^2}{dt^2} + \omega_0^2 + \gamma \frac{d}{dt} \right] \mathbf{r}_e(t) = -e\mathbf{E}(t). \quad (3.7)$$

For the sinusoidal electric field of an EM wave  $\mathbf{E}(t) \propto \exp(-i\omega t)$ , we would expect that

$$\mathbf{r}_e(t) = \mathbf{r}_{e,0} \exp(-i\omega t), \quad (3.8)$$

$$(d/dt)\mathbf{r}_e = -i\omega \mathbf{r}_e(t), \quad (3.9)$$

$$(d^2/dt^2)\mathbf{r}_e = -\omega^2 \mathbf{r}_e(t). \quad (3.10)$$

$$\therefore m_e [-\omega^2 + \omega_0^2 - i\gamma\omega] \mathbf{r}_e(t) = -e\mathbf{E}(t). \quad (3.11)$$

Hence, the dipole moment is

$$\mathbf{p}(t) = -e \mathbf{r}_e(t) = \frac{(e^2/m_e)}{\omega_0^2 - \omega^2 - i\gamma\omega} \mathbf{E}(t). \quad (3.12)$$

For  $n_j$  oscillators with natural frequencies  $\omega_j$  and damping coefficients  $\gamma_j$ , and on average  $f_j$  electrons with natural frequency  $\omega_j$  per atom, and  $N$  atoms per unit volume, the polarisation field is

$$\mathbf{P}(\mathbf{r}, t) = \frac{Ne^2}{m_e} \left( \sum_{j=1}^{n_j} \frac{f_j}{\omega_j^2 - \omega^2 - i\gamma_j\omega} \right) \mathbf{E}(\mathbf{r}, t). \quad (3.13)$$

But,  $\mathbf{P} = \chi_e \varepsilon_0 \mathbf{E}$  and  $\varepsilon = (1 + \chi_e) \varepsilon_0$ , and the refractive index must be

$$n(\omega) \approx \left( \frac{\varepsilon}{\varepsilon_0} \right)^{1/2} = \left( 1 + \frac{Ne^2}{\varepsilon_0 m_e} \sum_{j=1}^{n_j} \frac{f_j}{\omega_j^2 - \omega^2 - i\gamma_j \omega} \right)^{1/2}. \quad (3.14)$$

We see that the refractive index is complex, and so attenuation of the wave will occur although, as we shall shortly show, this is only important close to resonant frequencies  $\omega_j$ .

For gases the 2nd term in brackets is small, and we can approximate the square root by the 1st two terms of the binomial expansion

$$n(\omega) \approx 1 + \frac{Ne^2}{2\varepsilon_0 m_e} \sum_{j=1}^{n_j} \frac{f_j}{\omega_j^2 - \omega^2 - i\gamma_j \omega}, \quad (3.15)$$

$$\approx 1 + \frac{Ne^2}{2\varepsilon_0 m_e} \sum_{j=1}^{n_j} f_j \frac{(\omega_j^2 - \omega^2) + i\gamma_j \omega}{(\omega_j^2 - \omega^2)^2 + \gamma_j^2 \omega^2} \quad (3.16)$$

$$n(\omega) \approx \left( 1 + \frac{Ne^2}{2\varepsilon_0 m_e} \sum_{j=1}^{n_j} f_j \frac{(\omega_j^2 - \omega^2)}{(\omega_j^2 - \omega^2)^2 + \gamma_j^2 \omega^2} \right) + i \frac{Ne^2 \omega}{2\varepsilon_0 m_e} \sum_{j=1}^{n_j} f_j \frac{\gamma_j}{(\omega_j^2 - \omega^2)^2 + \gamma_j^2 \omega^2}. \quad (3.17)$$

Purely for illustration of the important features, I plot in Fig. 3.2 the refractive index for the rather unrealistic case where there are just two rather broad resonances.

The wave number  $k = \omega n/c$  is complex, and the equation for the real part

$$k_r(\omega) \approx \frac{\omega}{c} \left( 1 + \frac{Ne^2}{2\varepsilon_0 m_e} \sum_{j=1}^{n_j} f_j \frac{(\omega_j^2 - \omega^2)}{(\omega_j^2 - \omega^2)^2 + \gamma_j^2 \omega^2} \right), \quad (3.18)$$

is the the *dispersion relation* for the substance, and is used to find the phase velocity at a given frequency,  $v_p(\omega) = \omega/k_r(\omega)$ .

The absorption coefficient  $\alpha(\omega)$ , which has units  $[\text{m}^{-1}]$ , is obtained from the imaginary part of

the wave number

$$\alpha(\omega) = 2k_i(\omega) \quad (3.19)$$

$$= N \frac{e^2}{\epsilon_0 m_e c} \sum_{j=1}^{n_j} f_j \frac{\gamma_j \omega^2}{(\omega_j^2 - \omega^2)^2 + \gamma_j^2 \omega^2}. \quad (3.20)$$

Provided the resonances are narrow such that  $(\omega_j + \omega) \approx 2\omega$ , we may make the approximation

$$\alpha(\omega) \approx N \frac{\pi e^2}{\epsilon_0 m_e c} \sum_{j=1}^{n_j} f_j L(\omega) \quad (3.21)$$

where

$$L(\omega) = \frac{1}{\pi} \frac{(\gamma_j/2)}{(\omega_j - \omega)^2 + (\gamma_j/2)^2} \quad (3.22)$$

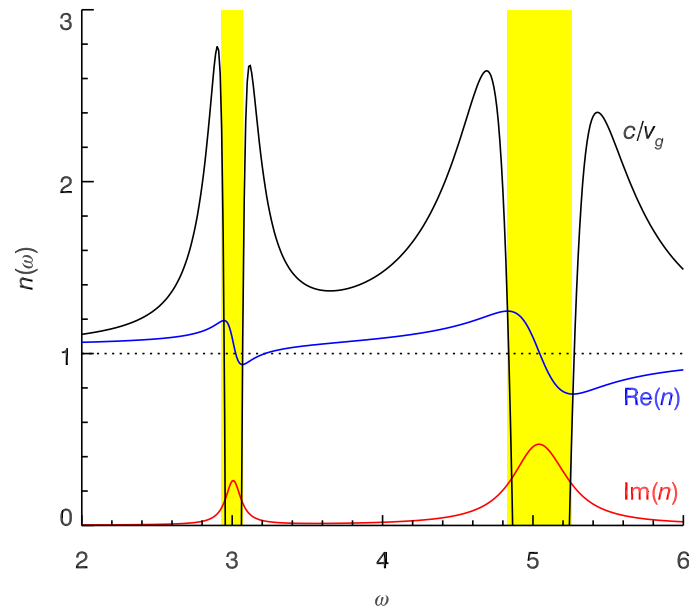
is the Lorentzian function plotted in Fig. 3.3.

"I studied English for 16 years but...  
...I finally learned to speak it in just six lessons"

Jane, Chinese architect

ENGLISH OUT THERE

Click to hear me talking before and after my unique course download

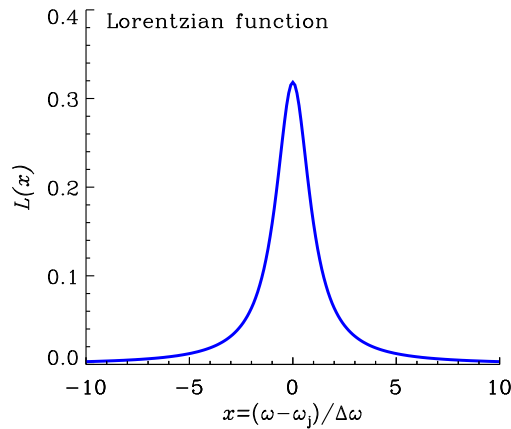


**Figure 3.2:** Refractive index and reciprocal group velocity in the Lorentz oscillator model for two resonances:  $\omega_1 = 3$ ,  $(Ne^2/\epsilon_0 m_e)f_1 = 0.2$ ,  $\gamma_1 = 0.12$ , and  $\omega_2 = 5$ ,  $(Ne^2/\epsilon_0 m_e)f_2 = 2$ ,  $\gamma_2 = 0.4$ . The yellow shaded regions show the frequency ranges where there is anomalous dispersion. The black curve shows  $c/v_g$  where  $v_g$  is the group velocity which I shall discuss later in this chapter.

The Lorentzian function has full width at half maximum (FWHM) equal to  $\gamma_j$  and is normalised to unit area, and describes the shape of absorption and emission lines, and is found in many physical situations, both quantum and classical, involving driven resonant systems. Heavily damped oscillators have broad line-widths — respond to a wider range of driving frequencies around a resonant frequency  $\omega_i$ . The spectral line-width depends on the  $Q$  factor, which is a measure of the sharpness of the resonance and depends on  $\gamma_i$ .

If we wish to apply this model to real materials, we need to replace the classical oscillators with resonance frequencies  $\omega_j$  with quantum oscillators corresponding to quantum transitions from level  $i$  to level  $k$  with absorption of a photon with energy close to  $\hbar\omega_{ik} = (E_k - E_i)$ , and with *oscillator strengths*  $f_{ik}$  and line-widths  $\gamma_{ik}$  determined using quantum mechanics.





**Figure 3.3:** The Lorentzian function.

## 3.2 Dispersion

For EM waves in a medium the phase velocity is

$$v_p(\omega) = \frac{\omega}{\operatorname{Re}\{k(\omega)\}} = \frac{c}{\operatorname{Re}\{n(\omega)\}}. \quad (3.23)$$

Since the refractive index depends on frequency, dispersion will occur. Dispersion causes different colours present in white light to be separated when passed through a glass prism, and wave packets to travel at a velocity called the *group velocity*.

### 3.2.1 Wave packets and group velocity

A wave packet is the superposition of a group of waves travelling together and localised in space at some initial time. For a wave packet travelling in the  $\hat{\mathbf{z}}$  direction with its electric field polarised in the  $\hat{\mathbf{y}}$  direction, say, and with  $E_y(z, 0)$  being the  $y$ -component of electric field at  $t = 0$ , there would be a distribution of wavenumbers given by the Fourier transform

$$\tilde{E}_y(k) = \int E_y(z, 0) e^{-ikz} dz. \quad (3.24)$$

We can recover the original electric field by taking the inverse Fourier transform

$$E_y(z, 0) = \frac{1}{2\pi} \int \tilde{E}_y(k) e^{ikz} dk. \quad (3.25)$$

$E_y(z, 0)$  and  $\tilde{E}_y(k)$  constitute Fourier transform pairs,  $E_y(z, 0) \iff \tilde{E}_y(k)$ . The electric field of the wave packet at a later time would be

$$E_y(z, t) = \frac{1}{2\pi} \int \tilde{E}_y(k) e^{i[kz - \omega(k)t]} dk. \quad (3.26)$$

We shall now derive the velocity at which the wave packets travel. For a narrow distribution of wavenumbers centred on  $k_0 = k(\omega_0)$  we can perform a Taylor series expansion of  $\omega(k)$  about  $\omega_0 = \omega(k_0)$ ,

$$\omega(k) = \omega_0 + (k - k_0) \left. \frac{d\omega}{dk} \right|_{\omega_0} + \frac{(k - k_0)^2}{2!} \left. \frac{d^2\omega}{dk^2} \right|_{\omega_0} + \dots, \quad (3.27)$$

and substitute just the first two terms above into Eq. 3.26 to obtain

Excellent Economics and Business programmes at:



**university of  
 groningen**




**“The perfect start  
 of a successful,  
 international career.”**

**CLICK HERE**  
 to discover why both socially  
 and academically the University  
 of Groningen is one of the best  
 places for a student to be

[www.rug.nl/feb/education](http://www.rug.nl/feb/education)

$$E_y(z, t) \approx \frac{1}{2\pi} \int \tilde{E}_y(k) \exp \left[ i \left( kz - \omega_0 t - k \left. \frac{d\omega}{dk} \right|_{\omega_0} t + k_0 \left. \frac{d\omega}{dk} \right|_{\omega_0} t \right) \right] dk, \quad (3.28)$$

$$\approx \frac{1}{2\pi} \exp \left[ i \left( k_0 \left. \frac{d\omega}{dk} \right|_{\omega_0} - \omega_0 \right) t \right] \int \tilde{E}_y(k) \exp \left[ ik \left( z - \left. \frac{d\omega}{dk} \right|_{\omega_0} t \right) \right] dk. \quad (3.29)$$

Taking the absolute values of both sides,

$$|E_y(z, t)| = \frac{1}{2\pi} \left| \int \tilde{E}_y(k) \exp \left[ ik \left( z - \left. \frac{d\omega}{dk} \right|_{\omega_0} t \right) \right] dk \right|. \quad (3.30)$$

Hence,

$$|E_y(z, t)| = \left| E_y \left( z - \left. \frac{d\omega}{dk} \right|_{\omega_0} t, 0 \right) \right| \quad (3.31)$$

which is in the form of a wave travelling with speed

$$v_g(\omega_0) \equiv \left. \frac{d\omega}{dk} \right|_{\omega_0} \quad (3.32)$$

which is the *group velocity* at angular frequency  $\omega_0$ .

The classic example is the gaussian wave packet which is obtained by multiplying a monochromatic plane wave by a gaussian envelope function

$$E_y(z, 0) = e^{-z^2/(2\sigma_z^2)} e^{-ik_0 z} \quad (3.33)$$

as in Fig. 3.4(a). Generally, for a wave packet spread out by  $\Delta z$  in  $z$ , the spread in wavenumbers is  $\Delta k \gtrsim 1/\Delta z$ . The Fourier transform of a gaussian is itself a gaussian

$$e^{-z^2/(2\sigma_z^2)} \iff \sqrt{2\pi} \sigma_z e^{-\sigma_z^2 k^2/2} \quad (3.34)$$

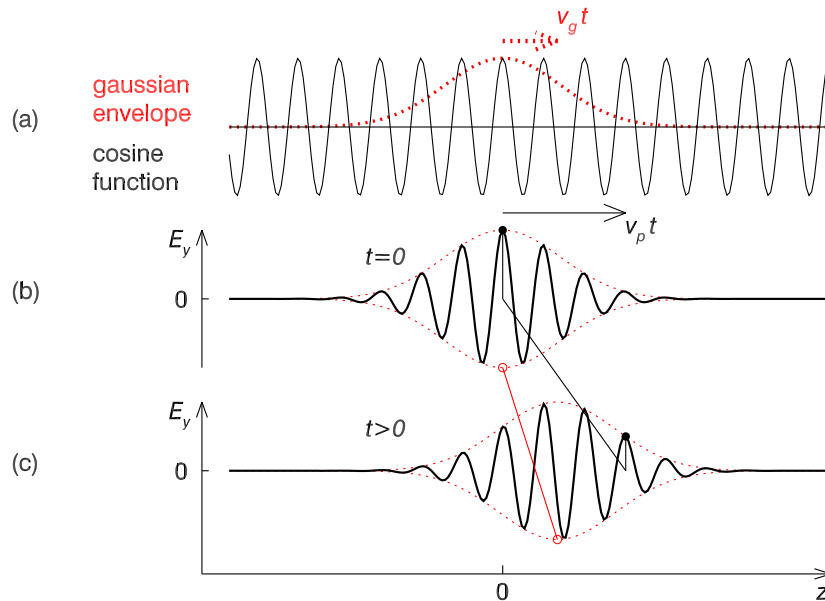
and for a monochromatic plane wave modulated by a gaussian envelope

$$e^{-z^2/(2\sigma_z^2)} e^{-ik_0 z} \iff \sqrt{2\pi} \sigma_z e^{-\sigma_z^2 (k-k_0)^2/2}. \quad (3.35)$$

Hence, the electric field at an arbitrary time  $t \geq 0$  is given by

$$E_y(z, t) = \int \frac{\sigma_z}{\sqrt{2\pi}} e^{-\sigma_z^2(k-k_0)^2/2} e^{i[kz - \omega(k)t]} dk. \quad (3.36)$$

Provided  $\Delta z \gg 1/k_0$  the wave packet propagates at the group velocity with an envelope of constant shape as illustrated by Figs. 3.4(b) and (c) for the example of a gaussian wave packet.



**Figure 3.4:** (a) Wave packet constructed by multiplying a monochromatic plane wave at  $t = 0$  (black cosine curve) by a gaussian envelope function (dotted red curve). (b) The wave packet at  $t = 0$ . (c) The wave packet at  $t > 0$ . The black line joining black dots connects positions of constant phase at the two times, while the red line joining hollow red dots connects positions of maximum amplitude where the envelope function peaks; in this example  $v_p > v_g$ .

### 3.2.2 Normal and anomalous dispersion

From looking at Figs. 3.4(b) and (c) it is clear that energy is transported with the wave packet at the group velocity, and provided  $v_g < c$  this satisfies special relativity and is termed *normal*

*dispersion*. In terms of the refractive index,

$$v_g(\omega) = \left( \frac{dk}{d\omega} \right)^{-1} \quad (3.37)$$

$$= \left[ \frac{d}{d\omega} \left( \frac{\omega \operatorname{Re}\{n(\omega)\}}{c} \right) \right]^{-1} \quad (3.38)$$

$$v_g(\omega) = c \left( \operatorname{Re}\{n(\omega)\} + \omega \frac{d\operatorname{Re}\{n\}}{d\omega} \right)^{-1}. \quad (3.39)$$

The speed of light divided by the group velocity has been added to Fig. 3.2 and we see that provided  $(d\operatorname{Re}\{n\}/d\omega) > 0$  there is normal dispersion, but for  $(d\operatorname{Re}\{n\}/d\omega) < 0$  the group velocity can exceed  $c$  and this is termed *anomalous dispersion*. Anomalous dispersion is always accompanied by absorption, and so the group velocity is then no longer a meaningful concept – in this case it is not the speed of transportation of energy or information – and so special relativity is not violated. The regions of anomalous dispersion are shown by the yellow shaded regions in Fig. 3.2.

## American online

## LIGS University

is currently enrolling in the  
Interactive Online **BBA, MBA, MSc,**  
**DBA and PhD** programs:

- ▶ enroll **by September 30th, 2014** and
- ▶ **save up to 16%** on the tuition!
- ▶ pay in 10 installments / 2 years
- ▶ Interactive **Online education**
- ▶ visit [www.ligsuniversity.com](http://www.ligsuniversity.com) to  
find out more!

Note: LIGS University is not accredited by any nationally recognized accrediting agency listed by the US Secretary of Education. More info [here](#).





### 3.3 Refractive index of a conductor

For EM wave propagation in a conductor we must include the current density  $\mathbf{J} = \sigma\mathbf{E}$ , where  $\sigma$  is the conductivity, when deriving the wave equation from Maxwell's equations in matter. Taking the curl of Faraday's law we derive the wave equation for the electric field

$$\nabla \times (\nabla \times \mathbf{E}) = \nabla \times (-\partial\mathbf{B}/\partial t) \quad (3.40)$$

$$\nabla(\nabla \cdot \mathbf{E}) - \nabla^2\mathbf{E} = -\frac{\partial}{\partial t}(\nabla \times \mathbf{B}) \quad (3.41)$$

$$0 - \nabla^2\mathbf{E} = -\frac{\partial}{\partial t} \left[ \mu\sigma\mathbf{E} + \mu\varepsilon \left( \frac{\partial\mathbf{E}}{\partial t} \right) \right] \quad (3.42)$$

$$\nabla^2\mathbf{E} - \mu\sigma\frac{\partial\mathbf{E}}{\partial t} - \mu\varepsilon\frac{\partial^2\mathbf{E}}{\partial t^2} = 0. \quad (3.43)$$

Similarly, from Ampere's law we can derive the wave equation for the magnetic field

$$\nabla^2\mathbf{B} - \mu\sigma\frac{\partial\mathbf{B}}{\partial t} - \mu\varepsilon\frac{\partial^2\mathbf{B}}{\partial t^2} = 0, \quad (3.44)$$

which we see has identical form. Substituting the monochromatic plane wave solution  $\mathbf{E} = \mathbf{E}_0 \exp\{i(\mathbf{k} \cdot \mathbf{r} - \omega t)\}$  into the wave equation we obtain

$$[-k^2 + \mu\sigma i\omega + \mu\varepsilon\omega^2]\mathbf{E} = 0, \quad (3.45)$$

and hence the dispersion relation for EM waves in a conductor

$$k(\omega) = (\mu\sigma i\omega + \mu\varepsilon\omega^2)^{1/2}. \quad (3.46)$$

For a good conductor  $\sigma \gg \varepsilon\omega$ , and so we have

$$k(\omega) \approx i^{1/2}(\mu\sigma\omega)^{1/2} \quad (3.47)$$

$$k(\omega) \approx (1+i)2^{-1/2}(\mu\sigma\omega)^{1/2} \quad (3.48)$$

where we have used  $i^{1/2} = (e^{i\pi/2})^{1/2} = e^{i\pi/4} = (\cos \frac{\pi}{4} + i \sin \frac{\pi}{4}) = (1+i)2^{-1/2}$ .

The wave number is complex and so the amplitude will decrease exponentially with distance

$$\langle E(\mathbf{r}, t) \rangle \propto \exp\left(-\text{Im}\{k(\omega)\}\hat{\mathbf{k}} \cdot \mathbf{r}\right) \propto \exp\left(-\hat{\mathbf{k}} \cdot \mathbf{r}/\delta(\omega)\right) \quad (3.49)$$

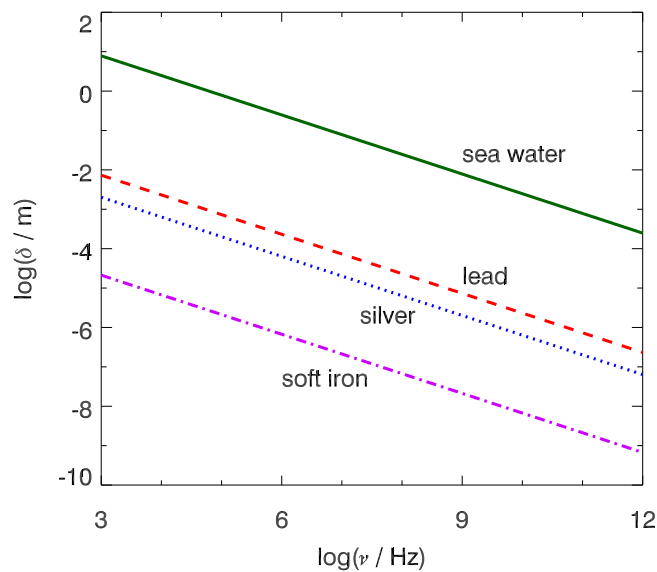
where

$$\delta(\omega) = \left(\frac{2}{\mu\sigma\omega}\right)^{1/2} \quad (3.50)$$

is called the *skin depth* and is plotted against frequency  $\nu = \omega/(2\pi)$  in Fig. 3.5 for soft iron, silver, lead and sea water. As an EM wave propagates through a conductor, intensity decreases as

$$I = I_0 \exp\left(-2\hat{\mathbf{k}} \cdot \mathbf{r}/\delta(\omega)\right) \quad (3.51)$$

so that the absorption coefficient  $\alpha(\omega) = 2/\delta(\omega)$ .



**Figure 3.5:** Skin depth of soft iron ( $\sigma = 11.2 \times 10^6 \Omega^{-1} \text{ m}^{-1}$ ,  $\mu_r = 50,000$ ), silver ( $\sigma = 62.1 \times 10^6 \Omega^{-1} \text{ m}^{-1}$ ), lead ( $\sigma = 4.7 \times 10^6 \Omega^{-1} \text{ m}^{-1}$ ), sea water at 20°C with 3% salinity ( $\sigma = 4.1 \Omega^{-1} \text{ m}^{-1}$ ).

As we have seen, at high frequencies EM waves cannot penetrate far inside a conductor. One example is sea water which has a skin depth of about 30 cm at 1 MHz and 10 m at 1 kHz, depending on temperature and salinity (see upper curve in Fig. 3.5). This causes radio com-

munication problems with submarines, and so VLF (3–30 kHz) or even ELF (300 Hz–3 kHz) frequencies are used instead.

A related phenomenon concerns the transmission of high frequency oscillating currents in conductors. These currents generate oscillating magnetic fields which induce electric fields, which in turn produce eddy currents and associated resistive power loss. These induced electric fields, which oppose the change in the magnetic field, are strongest in the centre of the conductor and effectively increase the resistivity there, with the upshot that the conduction current becomes confined to a thin outer layer of thickness comparable to the skin depth. Since the inside of a conducting wire is not used, a hollow wire works just as well and is lighter. Alternatively, plating a copper wire with a thin layer of silver (a better conductor) reduces power loss. Finally, EM waves (and associated energy) can be transmitted inside waveguides which, at microwave frequencies, are suitably designed hollow metal conducting pipes.

The reflectance of good conductors is high, and so a thin coating  $\sim 0.1 \mu\text{m}$  of silver or aluminium is deposited on the front surface of a concave parabolic or spherical glass surface in a reflecting telescope. The refractive index of a conductor is complex. However, we can still use the amplitude reflection coefficient for external reflection (air/metal) at normal incidence (for either polarisation), e.g. from Eq. 2.110, to obtain the reflectance (Exercise 3–1)


**DON'T EAT YELLOW SNOW**


What will your advice be?

Some advice just states the obvious. But to give the kind of advice that's going to make a real difference to your clients you've got to listen critically, dig beneath the surface, challenge assumptions and be credible and confident enough to make suggestions right from day one. At Grant Thornton you've got to be ready to kick start a career right at the heart of business.

Sound like you? Here's our advice: visit [GrantThornton.ca/careers/students](http://GrantThornton.ca/careers/students)

Scan here to learn more about a career with Grant Thornton.



 **Grant Thornton**  
An instinct for growth™

© Grant Thornton LLP. A Canadian Member of Grant Thornton International Ltd



$$R(0^\circ) = \frac{(1 - \operatorname{Re}\{n\})^2 + (\operatorname{Im}\{n\})^2}{(1 + \operatorname{Re}\{n\})^2 + (\operatorname{Im}\{n\})^2}. \quad (3.52)$$

Data on  $\operatorname{Re}\{n\}(\omega)$  and  $\operatorname{Im}\{n\}(\omega)$  are available and have been used together with Eq. 3.52 to calculate the reflectance as a function of wavelength for aluminium, silver, gold and copper shown in Fig. 3.6.

We are also able to estimate the refractive index of a good conductor from its conductivity using the formula we derived for the wave number (Eq. 3.48), and then use Eq. 3.52 to obtain an estimate of the reflectance, which has been added to Fig. 3.6 (dashed curves). As can be seen, clearly reality is much more complicated than our simple classical theory, and requires condensed matter theory for a proper understanding. Nevertheless, there is good agreement above  $2\mu\text{m}$  (2000 nm) in copper, and the agreement is acceptable above  $10\mu\text{m}$  (10,000 nm) in aluminium, gold and silver.

### 3.4 Wave propagation in dilute plasmas

In this section we consider wave propagation in an ionised plasma comprising  $n_e$  electrons and  $n_i$  ions per unit volume. In a dilute plasma we can ignore the (typically distant) ions as they provide little damping to the motion of the electrons, and because of their much higher mass they contribute little to the current density.

We start by deriving the electrical conductivity from the motion of individual electrons which undergo acceleration in response to the electric field of the wave

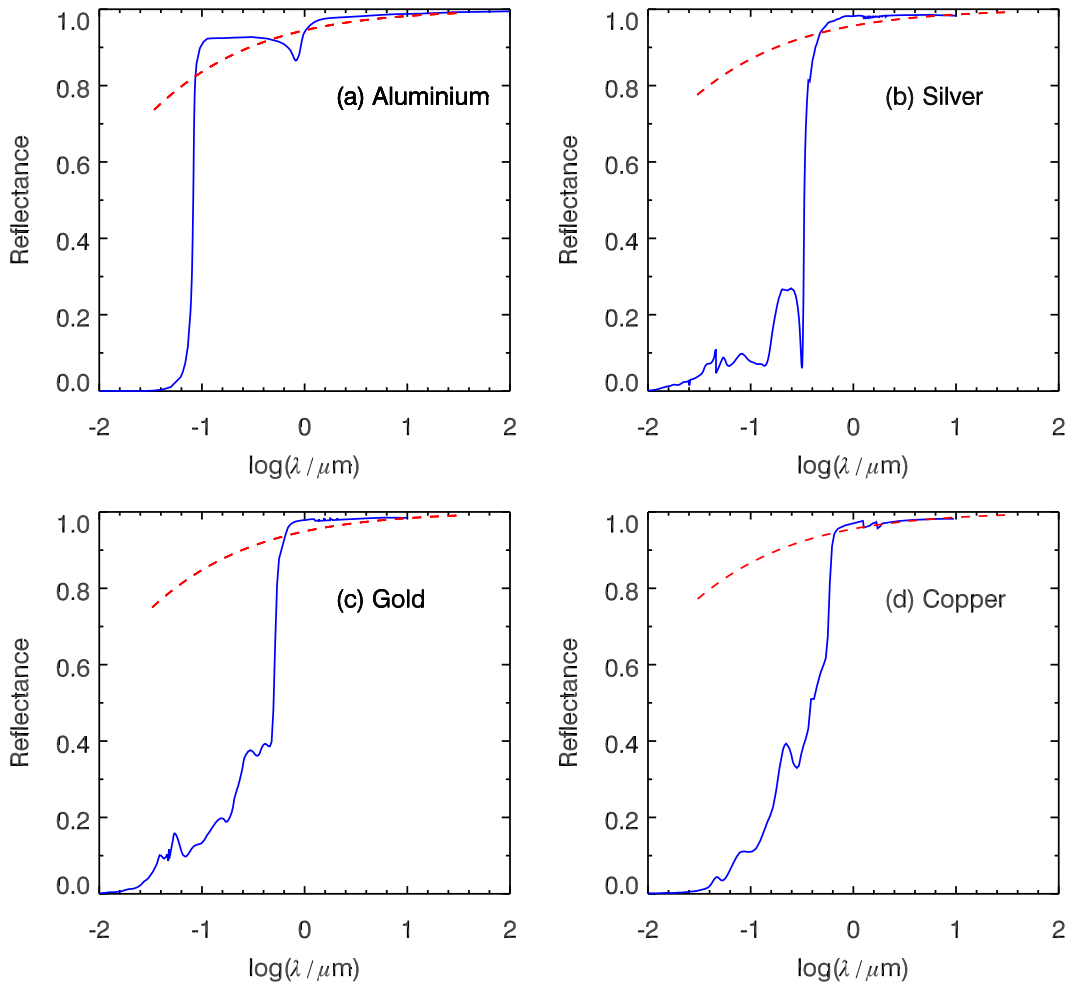
$$m_e \frac{d\mathbf{v}}{dt} = -e\mathbf{E}(t). \quad (3.53)$$

The current density arises from the bulk flow of electrons in the plasma

$$\mathbf{J}(t) = n_e(-e)\mathbf{v}(t), \quad (3.54)$$

and so

$$\frac{d\mathbf{J}}{dt} = \frac{n_e e^2}{m_e} \mathbf{E}(t). \quad (3.55)$$



**Figure 3.6:** Reflectances of aluminium, silver, gold and copper obtained using data on the complex refractive index (Palik 1985, Rakic 1995, Refractive Index Database <http://refractiveindex.info>) and Eq. 3.52 are shown by the solid curves. The dashed curves show the result for a good conductor using Eq. 3.48 and  $n = ck/\omega$  in Eq. 3.52 and resistivities at 0°C of aluminium, silver, gold and copper  $\rho = 1/\sigma = 2.42 \times 10^{-8}$ ,  $1.47 \times 10^{-8}$ ,  $2.05 \times 10^{-8}$  and  $1.54 \times 10^{-8}$   $\Omega$  m, respectively (Kaye & Laby [http://www.kayelaby.npl.co.uk/general\\_physics/2\\_6/2\\_6\\_1.html](http://www.kayelaby.npl.co.uk/general_physics/2_6/2_6_1.html)).

From this expression we can work out the conductivity for an oscillating electric field  $\mathbf{E}_0 e^{-i\omega t}$

$$\mathbf{J} = \frac{n_e e^2}{m_e} \mathbf{E}_0 \int e^{-i\omega t} dt, \quad (3.56)$$

$$= \frac{n_e e^2}{m_e} \mathbf{E}_0 \frac{1}{-i\omega} e^{-i\omega t}, \quad (3.57)$$

$$\therefore \mathbf{J} = i \frac{n_e e^2}{m_e \omega} \mathbf{E}. \quad (3.58)$$

We see that the conductivity is purely imaginary,

$$\sigma = i \frac{n_e e^2}{m_e \omega}, \quad (3.59)$$

so that the current density and electric field are  $90^\circ$  out of phase. Consequently, the time-averaged power will be zero. This is analogous to the current and voltage in an  $LC$  circuit where energy is continually being exchanged between electric field energy of the capacitor and magnetic field energy of the inductor.

.....Alcatel-Lucent 

[www.alcatel-lucent.com/careers](http://www.alcatel-lucent.com/careers)

What if you could build your future and create the future?

One generation's transformation is the next's status quo. In the near future, people may soon think it's strange that devices ever had to be "plugged in." To obtain that status, there needs to be "The Shift".



### 3.4.1 EM waves in dilute plasmas

In a dilute (low density) neutral ( $\rho = 0$ ) plasma we may assume  $\mu = \mu_0$  and  $\varepsilon = \varepsilon_0$ , and obtain the wave equation for  $\mathbf{E}$  in the usual way from the curl of Faraday's law, and substituting for  $d\mathbf{J}/dt$  using Eq. 3.55,

$$\nabla(\nabla \cdot \mathbf{E}) - \nabla^2 \mathbf{E} = -\frac{\partial}{\partial t}(\nabla \times \mathbf{B}), \quad (3.60)$$

$$0 - \nabla^2 \mathbf{E} = -\frac{\partial}{\partial t} \left[ \mu_0 \mathbf{J} + \mu_0 \varepsilon_0 \left( \frac{\partial \mathbf{E}}{\partial t} \right) \right], \quad (3.61)$$

$$\nabla^2 \mathbf{E} = \mu_0 \left( \frac{n_e e^2}{m_e} \mathbf{E} \right) + \mu_0 \varepsilon_0 \left( \frac{\partial^2 \mathbf{E}}{\partial t^2} \right). \quad (3.62)$$

$$\therefore \nabla^2 \mathbf{E} - \mu_0 \left( \frac{n_e e^2}{m_e} \right) \mathbf{E} - \frac{1}{c^2} \frac{\partial^2 \mathbf{E}}{\partial t^2} = 0. \quad (3.63)$$

Substituting the electric field of a monochromatic EM wave  $\mathbf{E} = \mathbf{E}_0 \exp\{i(\mathbf{k} \cdot \mathbf{r} - \omega t)\}$  into the wave equation we obtain

$$\left[ -k^2 - \frac{n_e e^2}{c^2 \varepsilon_0 m_e} + \frac{\omega^2}{c^2} \right] \mathbf{E} = 0, \quad (3.64)$$

and hence the dispersion relation

$$k^2 c^2 = \omega^2 - \omega_p^2, \quad (3.65)$$

where

$$\omega_p \equiv \left( \frac{n_e e^2}{\varepsilon_0 m_e} \right)^{1/2} \quad (3.66)$$

is the *plasma frequency*. EM waves cannot propagate if  $\omega < \omega_p$  as  $\mathbf{k}$  would be purely imaginary.

### 3.4.2 Phase and group velocity in dilute plasmas

From the dispersion relation (Eq. 3.65) we can derive the refractive index, phase and group velocities

$$n(\omega) = \frac{kc}{\omega} = \left(1 - \frac{\omega_p^2}{\omega^2}\right)^{1/2}, \quad (3.67)$$

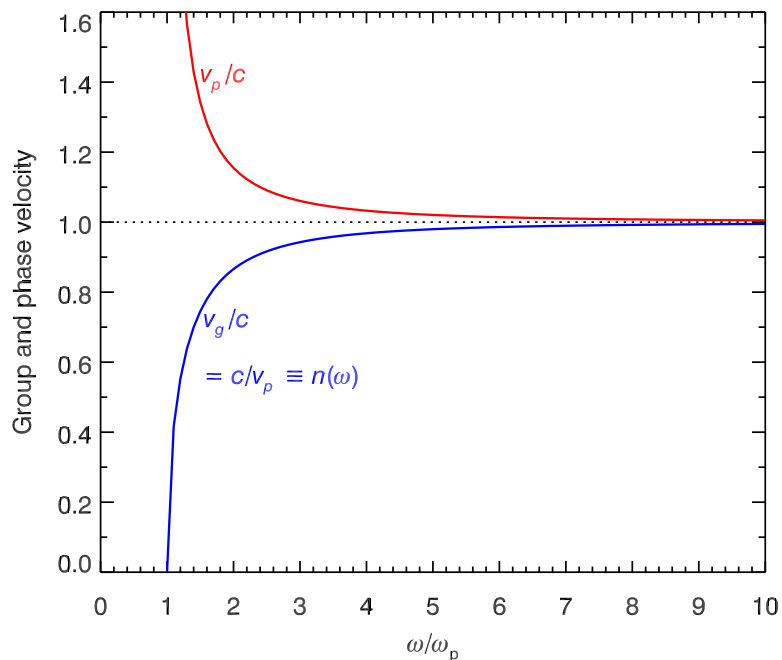
$$v_p(\omega) = \frac{\omega}{k} = c \left(1 - \frac{\omega_p^2}{\omega^2}\right)^{-1/2}, \quad (3.68)$$

$$v_g(\omega) = \left[\frac{dk}{d\omega}\right]^{-1} = c \left(1 - \frac{\omega_p^2}{\omega^2}\right)^{1/2}. \quad (3.69)$$

Note that for the case of a dilute plasma  $v_p v_g = c^2$ , and so

$$n(\omega) \equiv \frac{c}{v_p} = \frac{v_g}{c}. \quad (3.70)$$

The phase and group velocities, and refractive index are plotted in Fig. 3.7.



**Figure 3.7:** Phase velocity, group velocity and refractive index of a dilute plasma.

No EM wave propagation can occur below the plasma frequency which is the *cut-off frequency* of a dilute plasma. Above the cut-off frequency the phase velocity exceeds  $c$  but the group velocity is less than  $c$ .

### 3.4.3 Comparison of plasmas and dielectrics at high frequency

For frequencies well above the plasma frequency  $\omega_p$  the refractive index of a dilute plasma (Eq. 3.67) becomes

$$n(\omega) = \left(1 - \frac{\omega_p^2}{\omega^2}\right)^{1/2} \approx 1 - \frac{1}{2} \frac{\omega_p^2}{\omega^2}. \quad (3.71)$$

We shall show that the high frequency behaviour of the refractive index of a dielectric has the same form, and so may be approximated by the refractive index of a dilute plasma.



Join the best at  
the Maastricht University  
School of Business and  
Economics!

#### Top master's programmes

- 33<sup>rd</sup> place Financial Times worldwide ranking: MSc International Business
- 1<sup>st</sup> place: MSc International Business
- 1<sup>st</sup> place: MSc Financial Economics
- 2<sup>nd</sup> place: MSc Management of Learning
- 2<sup>nd</sup> place: MSc Economics
- 2<sup>nd</sup> place: MSc Econometrics and Operations Research
- 2<sup>nd</sup> place: MSc Global Supply Chain Management and Change

Sources: Keuzegids Master ranking 2013; Elsevier 'Beste Studies' ranking 2012; Financial Times Global Masters in Management ranking 2012

Maastricht University is the best specialist university in the Netherlands (Elsevier)

Visit us and find out why we are the best!  
Master's Open Day: 22 February 2014

[www.mastersopenday.nl](http://www.mastersopenday.nl)

For frequencies well above the highest resonant frequency, i.e.  $\omega \gg \omega_j$  for all  $j$ , we can neglect absorption (set  $\gamma_j = 0$ ). Then the refractive index of a dielectric in the Lorentz oscillator model (Eq. 3.17) becomes

$$n(\omega) \approx \left( 1 + \frac{Ne^2}{2\varepsilon_0 m_e} \sum_{j=1}^{n_j} f_j \frac{(\omega_j^2 - \omega^2)}{(\omega_j^2 - \omega^2)^2 + \gamma_j^2 \omega^2} \right) \quad (3.72)$$

$$\approx 1 - \frac{Ne^2}{2\varepsilon_0 m_e} \sum_{j=1}^{n_j} f_j \frac{1}{\omega^2} \quad (3.73)$$

$$\therefore n(\omega) \approx 1 - \frac{1}{2} \frac{\omega_p^2}{\omega^2} \quad (3.74)$$

where

$$\omega_p \equiv \left( \frac{N'e^2}{\varepsilon_0 m_e} \right)^{1/2} \quad (3.75)$$

and  $N' = N \sum_{j=1}^{n_j} f_j$  is the total number density of electron oscillators. This is identical to the refractive index of a plasma at high frequency (Eq. 3.71).

### 3.4.4 Dispersion of pulses from a pulsar

Pulsars (magnetised neutron stars) emit one or more narrow radio pulses every rotation period, rather like a lighthouse. The interstellar medium is partly ionised and the electron number density varies throughout the Galaxy – the average value in the Galactic plane is  $n_e \sim 3 \times 10^{-7} \text{ m}^{-3}$  giving  $\nu_p \equiv \omega_p/2\pi \sim 50 \text{ kHz}$ . Pulses travel at  $v_g(\nu)$ , so high frequencies arrive earlier than low frequencies, with pulses at extremely high frequencies travelling at  $c$ .

Pulsars are often observed by radio telescopes at two or more frequencies, typically at 650 MHz to 700 MHz frequencies, well above the plasma frequency. The time delay of a pulse at angular frequency  $\omega$  from a pulsar at distance  $L$  with respect to the same pulse observed at angular frequency  $\omega \rightarrow \infty$  is

$$t(\omega) = \int_0^L \frac{dr}{v_g(\mathbf{r}, \omega)} - \frac{L}{c} \quad (3.76)$$

where, for  $\omega \gg \omega_p$  as is the case for radio observations, we obtain from Eq. 3.69 and Eq. 3.66

$$\frac{1}{v_g(\mathbf{r}, \omega)} = \frac{1}{c} \left( 1 - \frac{[\omega_p(n_e)]^2}{\omega^2} \right)^{-1/2} \approx \frac{1}{c} \left( 1 + \frac{1}{2} \frac{[\omega_p(n_e)]^2}{\omega^2} \right) = \frac{1}{c} \left( 1 + \frac{n_e(\mathbf{r}) e^2}{2\varepsilon_0 m_e \omega^2} \right). \quad (3.77)$$

Hence,

$$t(\omega) = \frac{e^2}{2\varepsilon_0 m_e c} \text{DM} \omega^{-2} = \frac{e^2}{8\pi^2 \varepsilon_0 m_e c} \text{DM} \nu^{-2} \quad (3.78)$$

where the *dispersion measure* is

$$\text{DM} \equiv \int_0^L n_e(\mathbf{r}) dr. \quad (3.79)$$

The dispersion measure can be found from the pulse delays at two or more frequencies, giving the pulsar's distance  $L$  if  $n_e(\mathbf{r})$  along the line of sight to the pulsar is known. If  $L$  is known, e.g. by parallax or other methods, the observed dispersion measures of pulsars throughout the Galaxy can be used to refine models of  $n_e(\mathbf{r})$ .

Identical physics applies to radio pulses propagating through the ionosphere between, e.g. Global Positioning System (GPS) satellites, and the Earth. In this case the relevant quantities are the *vertical total electron content*

$$\text{VTEC} \equiv \int_0^\infty n_e(h) dh, \quad (3.80)$$

where  $h$  is the altitude, and the slant total electron content  $\text{STEC} = \text{VTEC} \times \sec \theta$  where  $\theta$  is the zenith angle of the satellite as seen by the tracking station. VTEC and STEC are usually measured in units of 1 TECU =  $10^{16}$  electrons  $\text{m}^{-2}$ .

### 3.4.5 Faraday rotation and applications to radio astronomy

When a linearly polarised wave propagates through a magnetised plasma (or dielectric), its plane of polarisation rotates. This effect was observed by Michael Faraday for polarised light passing through a dielectric in the presence of a magnetic field. It is caused by the phase velocity being different for right and left circularly polarised waves. We can most easily show this for



the case of a dilute plasma in which there is a component of magnetic field present along the direction of wave propagation.

For convenience let's assume that  $\mathbf{B} = B_{\parallel} \hat{\mathbf{z}}$  and that the wave propagates in the  $+\hat{\mathbf{z}}$  direction. Then using the (unnormalised) basis vectors for circular polarisation (Eq. 2.67), at  $z = 0$  the electric field of a right-circularly polarised wave is

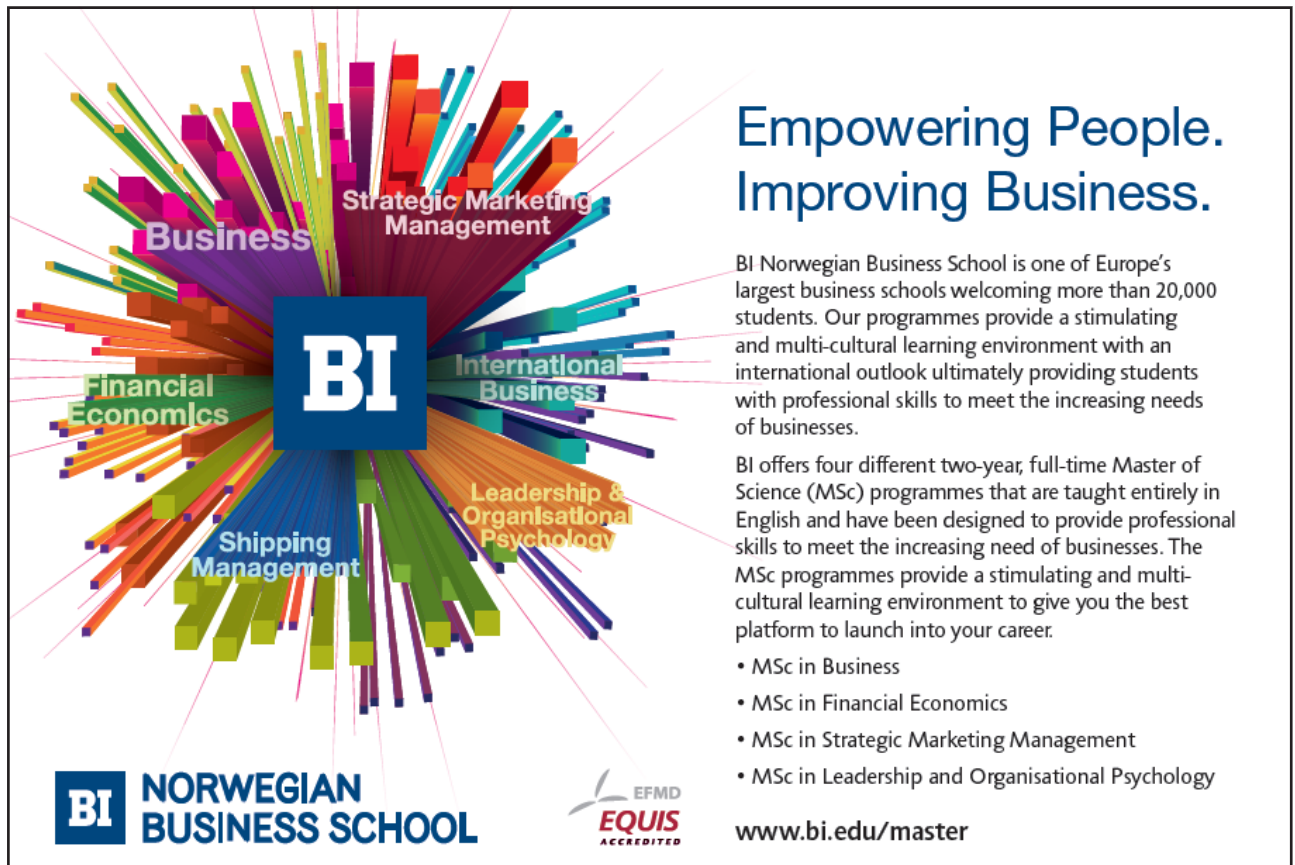
$$\mathbf{E}(x, y, 0, t) = E_R \mathbf{e}_R e^{-i\omega t} = E_R (\hat{\mathbf{x}} - i\hat{\mathbf{y}}) e^{-i\omega t}. \quad (3.81)$$

Furthermore, let's assume that electrons located at  $z = 0$  will undergo circular motion in the constant magnetic field in response to the electric field of the wave. For convenience consider an electron orbiting around the origin. Its position will be

$$\mathbf{r}(t) = r_R \mathbf{e}_R e^{-i\omega t} = r_R (\hat{\mathbf{x}} - i\hat{\mathbf{y}}) e^{-i\omega t}, \quad (3.82)$$

$$\text{Re}\{\mathbf{r}(t)\} = r_R \cos(\omega t) \hat{\mathbf{x}} - r_R \sin(\omega t) \hat{\mathbf{y}} \quad (3.83)$$

which clearly describes circular motion with radius  $r_R$ .



**Empowering People. Improving Business.**

BI Norwegian Business School is one of Europe's largest business schools welcoming more than 20,000 students. Our programmes provide a stimulating and multi-cultural learning environment with an international outlook ultimately providing students with professional skills to meet the increasing needs of businesses.

BI offers four different two-year, full-time Master of Science (MSc) programmes that are taught entirely in English and have been designed to provide professional skills to meet the increasing need of businesses. The MSc programmes provide a stimulating and multi-cultural learning environment to give you the best platform to launch into your career.

- MSc in Business
- MSc in Financial Economics
- MSc in Strategic Marketing Management
- MSc in Leadership and Organisational Psychology

[www.bi.edu/master](http://www.bi.edu/master)

**BI NORWEGIAN BUSINESS SCHOOL**

EFMD EQUIS ACCREDITED

Applying the Lorentz force law  $m_e \ddot{\mathbf{r}} = -e(\mathbf{E} + \dot{\mathbf{r}} \times \mathbf{B})$  to an electron orbiting in the  $xy$  plane around the origin in the presence of magnetic field  $\mathbf{B} = B_{\parallel} \hat{\mathbf{z}}$  and a right-circularly polarised wave propagating in the  $\hat{\mathbf{z}}$  direction (Eq. 3.81),

$$-m_e \omega^2 r_R \mathbf{e}_R e^{-i\omega t} = -e (E_R \mathbf{e}_R e^{-i\omega t} - i\omega r_R \mathbf{e}_R e^{-i\omega t} \times B_{\parallel} \hat{\mathbf{z}}), \quad (3.84)$$

$$m_e \omega^2 r_R (\hat{\mathbf{x}} - i\hat{\mathbf{y}}) = e [E_R (\hat{\mathbf{x}} - i\hat{\mathbf{y}}) - i\omega r_R (\hat{\mathbf{x}} - i\hat{\mathbf{y}}) \times B_{\parallel} \hat{\mathbf{z}}], \quad (3.85)$$

$$m_e \omega^2 r_R (\hat{\mathbf{x}} - i\hat{\mathbf{y}}) = e [E_R (\hat{\mathbf{x}} - i\hat{\mathbf{y}}) - i\omega r_R (-\hat{\mathbf{y}} - i\hat{\mathbf{x}}) B_{\parallel}], \quad (3.86)$$

$$m_e \omega^2 r_R (\hat{\mathbf{x}} - i\hat{\mathbf{y}}) = e [E_R (\hat{\mathbf{x}} - i\hat{\mathbf{y}}) - \omega r_R (\hat{\mathbf{x}} - i\hat{\mathbf{y}}) B_{\parallel}]. \quad (3.87)$$

$$\therefore r_R = \frac{eE_R}{m_e \omega^2 + e\omega B_{\parallel}}. \quad (3.88)$$

Using this result we can immediately write down the dipole moment  $p_R = -er_R$ , polarisation field  $P_R = \chi_R \varepsilon_0 E_R$ , electric susceptibility  $\chi_R$ , permittivity  $\varepsilon_R = (1 + \chi_R)\varepsilon_0$ , refractive index  $n_R \approx \sqrt{\varepsilon_R/\varepsilon_0}$  and wave number  $k_R = \omega n_R/c$  for number density  $n_e$  of electrons,

$$p_R = -e \frac{eE_R}{m_e \omega^2 + e\omega B_{\parallel}}, \quad (3.89)$$

$$P_R = -\frac{n_e e^2}{m_e} \omega^{-2} \left(1 + \frac{\omega_c}{\omega}\right)^{-1} E_R, \quad (3.90)$$

$$\chi_R = -\frac{\omega_p^2}{\omega^2} \left(1 + \frac{\omega_c}{\omega}\right)^{-1}, \quad (3.91)$$

$$\varepsilon_R = \left[1 - \frac{\omega_p^2}{\omega^2} \left(1 + \frac{\omega_c}{\omega}\right)^{-1}\right] \varepsilon_0, \quad (3.92)$$

$$n_R = \left[1 - \frac{\omega_p^2}{\omega^2} \left(1 + \frac{\omega_c}{\omega}\right)^{-1}\right]^{1/2}, \quad (3.93)$$

$$k_R = \frac{\omega}{c} \left[1 - \frac{\omega_p^2}{\omega^2} \left(1 + \frac{\omega_c}{\omega}\right)^{-1}\right]^{1/2}, \quad (3.94)$$

where  $\omega_c = eB_{\parallel}/m_e$  is the electron cyclotron frequency and  $\omega_p$  is the plasma frequency (Eq. 3.66).

Provided  $\omega \gg \omega_p$  and  $\omega \gg \omega_c$

$$k_R \approx \frac{\omega}{c} \left[1 - \frac{1}{2} \frac{\omega_p^2}{\omega^2} \left(1 + \frac{\omega_c}{\omega}\right)^{-1}\right] \approx \frac{\omega}{c} \left[1 - \frac{1}{2} \frac{\omega_p^2}{\omega^2} \left(1 - \frac{\omega_c}{\omega}\right)\right] \approx (k_0 + \Delta k), \quad (3.95)$$

where  $k_0 \approx \frac{\omega}{c} \left( 1 - \frac{1}{2} \frac{\omega_p^2}{\omega^2} \right)$  is the high-frequency approximation for the wave number in an unmagnetised plasma and

$$\Delta k = \frac{1}{2} \frac{\omega_p^2 \omega_c}{\omega^2 c}. \quad (3.96)$$

Similarly, for left-circular polarisation

$$k_L \approx \frac{\omega}{c} \left[ 1 - \frac{1}{2} \frac{\omega_p^2}{\omega^2} \left( 1 + \frac{\omega_c}{\omega} \right) \right] \approx (k_0 - \Delta k). \quad (3.97)$$

Now consider a plane-polarised wave propagating in the  $\hat{\mathbf{z}}$  direction and being initially polarised in the  $\hat{\mathbf{x}}$  direction, i.e.  $\mathbf{E}(x, y, 0, t) = E_0 \hat{\mathbf{x}} e^{-i\omega t} = (E_0/2)(\mathbf{e}_L + \mathbf{e}_R) e^{-i\omega t}$ . After propagating distance  $z$  the electric field is

$$\mathbf{E}(x, y, z, t) = \frac{E_0}{2} \left( \mathbf{e}_L e^{ik_L z} + \mathbf{e}_R e^{ik_R z} \right) e^{-i\omega t}, \quad (3.98)$$

$$= \frac{E_0}{2} \left[ (\hat{\mathbf{x}} + i\hat{\mathbf{y}}) e^{-i\Delta k z} + (\hat{\mathbf{x}} - i\hat{\mathbf{y}}) e^{i\Delta k z} \right] e^{i(k_0 z - \omega t)}, \quad (3.99)$$

$$= \frac{E_0}{2} \left[ \hat{\mathbf{x}} \left( e^{i\Delta k z} + e^{-i\Delta k z} \right) - i\hat{\mathbf{y}} \left( e^{i\Delta k z} - e^{-i\Delta k z} \right) \right] e^{i(k_0 z - \omega t)}, \quad (3.100)$$

$$= E_0 \left[ \hat{\mathbf{x}} \cos(\Delta k z) + \hat{\mathbf{y}} \sin(\Delta k z) \right] e^{i(k_0 z - \omega t)}. \quad (3.101)$$

Hence the plane of polarisation at frequency  $\nu$  has rotated with respect to that at  $\nu \rightarrow \infty$  by angle

$$\theta = \Delta k z = \frac{1}{2} \frac{\omega_p^2 \omega_c}{\omega^2 c} z = \frac{1}{2} \frac{n_e e^3}{\varepsilon_0 m_e^2 c} \frac{1}{\omega^2} B_{\parallel} z = \frac{1}{8\pi^2} \frac{n_e e^3}{\varepsilon_0 m_e^2 c^3} \lambda^2 B_{\parallel} z. \quad (3.102)$$

Since the high-frequency behaviour of a dielectric is essentially identical to that of a plasma, the formula above applies equally to dilute plasmas or dielectrics at high frequency.

Faraday rotation is a valuable tool which radio astronomers use for measuring the magnetic field in the interstellar medium or in clusters of galaxies. By observing the polarisation angle of radio emission from a polarised background source such as pulsar or quasar at two or more

frequencies, one can solve for the the *rotation measure*

$$RM \equiv \frac{\theta}{\lambda^2} = \frac{1}{8\pi^2} \frac{n_e e^3}{\epsilon_0 m_e^2 c^3} \int n_e(\mathbf{r}) \mathbf{B}(\mathbf{r}) \cdot d\mathbf{r} \quad (3.103)$$

$$= 2.63 \times 10^{-13} \int n_e(\mathbf{r}) \mathbf{B}(\mathbf{r}) \cdot d\mathbf{r} \quad (\text{rad m}^{-2}), \quad (3.104)$$

along the line of sight. In the case of pulsars, dividing  $\int n_e(\mathbf{r}) \mathbf{B}(\mathbf{r}) \cdot d\mathbf{r}$  obtained from the  $RM$  by the dispersion measure  $DM = \int n_e(\mathbf{r}) dr$  (Eq. 3.79) gives the weighted average value of the component of magnetic field along the line of sight (weighted by the free electron density).

## Summary of important concepts and equations

### Complex wavenumber and absorption

— Electric field,  $\mathbf{E}(\mathbf{r}, t) = \mathbf{E}_0 e^{i(\text{Re}\{k\}\hat{\mathbf{k}}\cdot\mathbf{r} - \omega t)} e^{-\text{Im}\{k\}\hat{\mathbf{k}}\cdot\mathbf{r}}$

## Need help with your dissertation?

Get in-depth feedback & advice from experts in your topic area. Find out what you can do to improve the quality of your dissertation!

Get Help Now



Go to [www.helpmyassignment.co.uk](http://www.helpmyassignment.co.uk) for more info



Helpmyassignment

- Intensity,  $I = I_0 e^{-\alpha \hat{\mathbf{k}} \cdot \mathbf{r}}$
- Absorption coefficient,  $\alpha = 2 \times \text{Im}\{k(\omega)\}$

### Lorentz Oscillator Model of Dielectric

- Nucleus surrounded by electron “cloud” acting as simple harmonic oscillator: resonant frequency  $\omega_0$ ; damping constant  $\gamma$
- Equation of motion of the electron  $m_e \left[ \frac{d^2}{dt^2} + \omega_0^2 + \gamma \frac{d}{dt} \right] \mathbf{r}_e(t) = -e\mathbf{E}(t)$
- For  $f_j$  electrons with resonant frequency  $\omega_j$  and damping coefficient  $\gamma_j$ , and  $N$  molecules per unit volume,

$$\mathbf{P}(\mathbf{r}, t) = \frac{Ne^2}{m_e} \left( \sum_{j=1}^{n_j} \frac{f_j}{\omega_j^2 - \omega^2 - i\gamma_j \omega} \right) \mathbf{E}(\mathbf{r}, t).$$

$$n(\omega) \approx \left( 1 + \frac{Ne^2}{\epsilon_0 m_e} \sum_{j=1}^{n_j} \frac{f_j}{\omega_j^2 - \omega^2 - i\gamma_j \omega} \right)^{1/2}.$$

- Absorption coefficient near a resonance has a Lorentzian profile

$$L(\omega) = \frac{1}{\pi} \frac{(\gamma_j/2)}{(\omega_j - \omega)^2 + (\gamma_j/2)^2}$$

### Dispersion

- Phase propagates at the phase velocity  $v_p(\omega) \equiv \frac{\omega}{k} \Big|_{\omega}$
- Wave packets travel at the group velocity  $v_g(\omega) \equiv \frac{d\omega}{dk} \Big|_{\omega}$
- Information and energy travel at  $v_g$
- If  $(d\text{Re}\{n\}/d\omega) < 0$  (anomalous dispersion) the group velocity can exceed  $c$ , but anomalous dispersion is accompanied by absorption, so causality is not violated

### Refractive index of a conductor

- Wave equation:  $\nabla^2 \mathbf{E} - \mu\sigma \frac{\partial \mathbf{E}}{\partial t} - \mu\epsilon \frac{\partial^2 \mathbf{E}}{\partial t^2} = 0$
- Dispersion relation for good conductor:  $k(\omega) \approx (1 + i)2^{-1/2}(\mu\sigma\omega)^{1/2}$
- Skin depth  $\delta(\omega) = \left(\frac{2}{\sigma\mu\omega}\right)^{1/2}$
- Absorption coefficient  $\alpha(\omega) = 2/\delta(\omega)$

### Wave propagation in dilute plasmas

- $n_e$  electrons and  $n_i$  ions per unit volume – ignore ions in dilute plasma
- Wave equation  $\nabla^2 \mathbf{E} - \mu_0 \left(\frac{n_e e^2}{m_e}\right) \mathbf{E} - \frac{1}{c^2} \frac{\partial^2 \mathbf{E}}{\partial t^2} = 0$
- Dispersion relation  $k^2 c^2 = \omega^2 - \omega_p^2$
- Plasma frequency  $\omega_p \equiv \left(\frac{n_e e^2}{\epsilon_0 m_e}\right)^{1/2}$
- EM waves cannot propagate if  $\omega < \omega_p$  (cut-off frequency)
- Above  $\omega_p$ :  $v_p > c$  and  $v_g < c$
- At frequencies above the highest resonance frequency a dielectric behaves like a dilute plasma

### Faraday rotation

- In a magnetised plasma or dielectric, left and right circularly polarised waves travel at different phase velocities
- For plane-polarised waves this causes the plane of polarisation to rotate by angle

$$\Delta\theta = \frac{1}{2} \frac{n_e e^3}{\epsilon_0 m_e^2 c} \frac{1}{\omega^2} B_{\parallel} z.$$

where  $B_{\parallel}$  is the component of the magnetic field parallel to the wave direction

## Exercises on Chapter 3

- 3-1 The resistivity of silver is  $\rho = 1.6 \times 10^{-8} \Omega \text{ m}$ , and its permeability is  $\mu = 0.9998\mu_0$ , find the reflectance for light of wavelength 500 nm at normal incidence from air.
- 3-2 Show that the time-averaged power density  $\langle \mathbf{E} \cdot \mathbf{J} \rangle$  in a dilute plasma is zero.
- 3-3 At midnight and noon, at a certain location and date, the electron number density in the ionosphere was as given in the plot below.
- Label the x-axis at the top of the plot in terms of the plasma frequency  $\nu_p$  (MHz).
  - Find the height of the reflecting layer at 1 MHz and 3 MHz at midnight and noon.
  - Find the minimum frequencies for communication with orbiting satellites at midnight and noon.
  - Estimate the total electron content in (electrons  $\text{m}^{-2}$ ) at midnight and noon.
  - An instantaneous broad-band pulse of radio-frequency interference (RFI) is emitted overhead by an orbiting satellite and observed by an terrestrial detector with a bandwidth from 1.2–1.8 GHz. What is the duration of the observed pulse?



**Brain power**

By 2020, wind could provide one-tenth of our planet's electricity needs. Already today, SKF's innovative know-how is crucial to running a large proportion of the world's wind turbines.

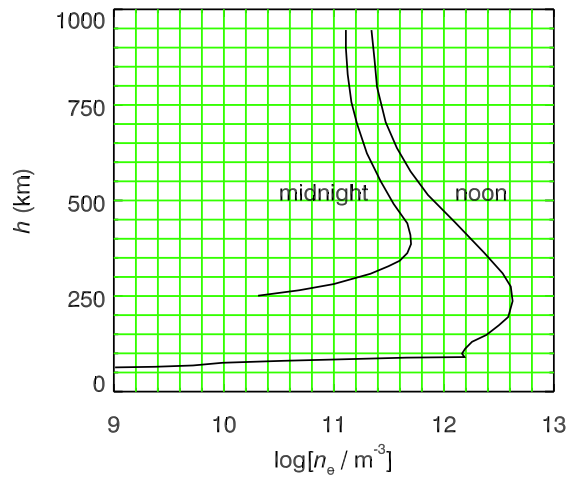
Up to 25 % of the generating costs relate to maintenance. These can be reduced dramatically thanks to our systems for on-line condition monitoring and automatic lubrication. We help make it more economical to create cleaner, cheaper energy out of thin air.

By sharing our experience, expertise, and creativity, industries can boost performance beyond expectations. Therefore we need the best employees who can meet this challenge!

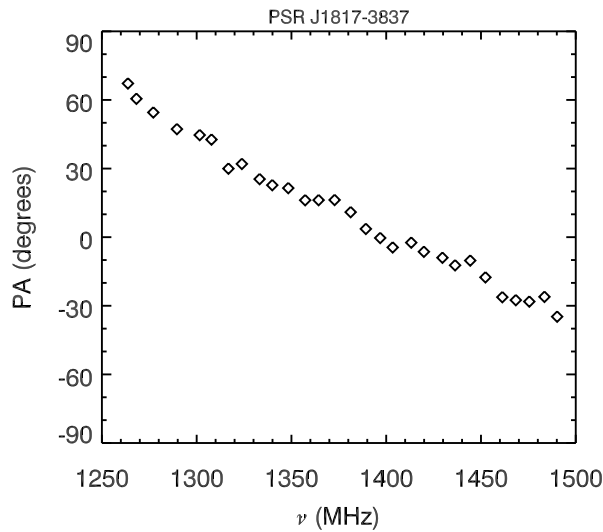
The Power of Knowledge Engineering

Plug into The Power of Knowledge Engineering.  
Visit us at [www.skf.com/knowledge](http://www.skf.com/knowledge)

**SKF**



3–4 For pulsar PSR J1817-3837 the observed position angle (PA) of linear polarisation with respect to the North Celestial Pole is plotted below vs. frequency. The dispersion measure is  $102.85 \text{ pc cm}^{-3}$ , where  $1 \text{ pc} = 3.09 \times 10^{16} \text{ m}$  (1 parsec) is the distance unit used by astronomers. Find the average value of the parallel component of the magnetic field along the line of sight to this pulsar.



3–5 We are receiving radio signals from an interplanetary space probe which is far from the Sun. It is currently on a trajectory such that it has been eclipsed by the Sun, but it is now emerging from behind the Sun. The space probe regularly broadcasts instantaneous broadband pulses of radio-frequency emission every second, and it also broadcasts spacecraft experiment instrument data over a narrow frequency band of width 100 kHz extending from



10,000.0 MHz to 10,000.1 MHz. It transmits using a dipole antenna aligned perpendicular to the plane of the ecliptic (the plane containing the Earth's orbit). We are just renewing radio contact as the space probe is emerging from behind the solar limb.

The Sun's corona is an extremely hot ( $> 10^6$  K) plasma which is highly variable, and has dynamic coronal loops of magnetised plasma. The corona is located above the Sun's photosphere. At the time we are observing, the base of the corona in front of the space probe as it emerges from behind the Sun has an electron number density of  $n_e(R_\odot) \sim 3 \times 10^{15} \text{ m}^{-3}$ . The corona's a scale height is about  $H \sim 10^8$  m, such that the electron number density decreases with height as  $n_e(r) = n_e(R_\odot) \exp[-(r - R_\odot)/H]$ . Imagine that, at the time we are observing, the Sun's magnetic dipole moment is  $m = 2 \times 10^{29} \text{ A m}^2$  and it happens to be pointing directly towards Earth.

- What is the minimum radio frequency that we are able to receive from the space probe?
- What is the additional delay of the pulses due to propagation through the corona?
- By how much has the plane of polarisation of the EM wave carrying the data signal rotated due to propagation through the corona?

[Make what you think are reasonable approximations – do not attempt a rigorous calculation. The radius of the solar photosphere is  $R_\odot = 6.955 \times 10^8$  m.]

## TURN TO THE EXPERTS FOR SUBSCRIPTION CONSULTANCY

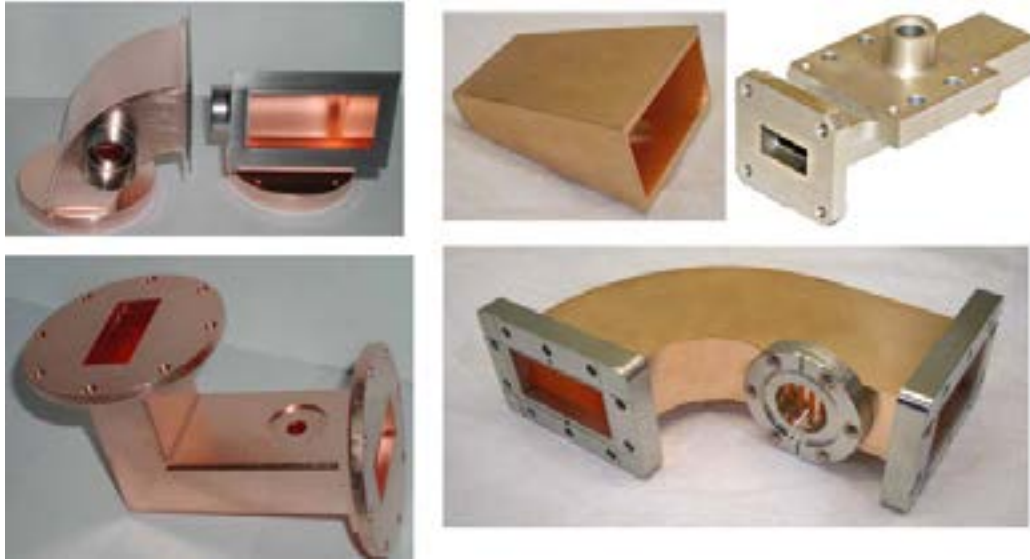
Subscribe is one of the leading companies in Europe when it comes to innovation and business development within subscription businesses.

We innovate new subscription business models or improve existing ones. We do business reviews of existing subscription businesses and we develop acquisition and retention strategies.

Learn more at [linkedin.com/company/subscribe](https://www.linkedin.com/company/subscribe) or contact Managing Director Morten Suhr Hansen at [mha@subscribe.dk](mailto:mha@subscribe.dk)

**SUBSCR**✓**IBE** - to the future

## 4 Waveguides



**Figure 4.1:** An assortment of waveguide components. (Image reproduced with permission, courtesy of Altair Technologies, Inc., <http://www.altairusa.com/index.php>).

### Learning objectives

- To be able to show that the boundary conditions at the surface of a perfect conductor forbid transverse electromagnetic (TEM) waves propagating inside a waveguide, but allow transverse electric (TE) waves and transverse magnetic (TM) waves.
- To understand that the field of a monochromatic EM wave propagating inside a rectangular waveguide with  $\mathbf{k} = k\hat{\mathbf{z}}$  can be written

$$\mathbf{E}(x, y, z, t) = \mathbf{E}_0(x, y)e^{i(kz - \omega t)}, \quad \mathbf{B}(x, y, z, t) = \mathbf{B}_0(x, y)e^{i(kz - \omega t)}.$$

where the field amplitude functions  $\mathbf{E}_0(x, y)$  and  $\mathbf{B}_0(x, y)$  can be found by substitution into Maxwell's equations in differential form and applying the boundary conditions.

- To know that by using Faraday's and Ampere's laws we get equations for the  $x$  and  $y$  components of  $\mathbf{E}_0(x, y)$  and  $\mathbf{B}_0(x, y)$  in terms of the  $z$  components, and that by subsequently using  $\nabla \cdot \mathbf{E} = 0$  and  $\nabla \cdot \mathbf{B} = 0$  we obtain partial differential equations for the  $z$  components of  $\mathbf{E}_0(x, y)$  and  $\mathbf{B}_0(x, y)$  which can be solved by separation of variables leading to various discrete TE and TM modes.

- To be able to apply the boundary conditions to obtain the dispersion relation, phase and group velocities for each of the  $\text{TM}_{mn}$  and  $\text{TE}_{mn}$  modes, and show that each mode has a cut-off frequency  $\omega_{mn}$ , the lowest being for the  $\text{TE}_{10}$  mode.

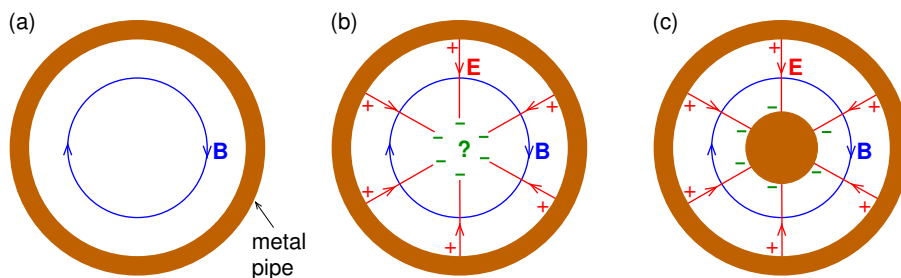
Waveguides are devices used to guide electromagnetic waves. At optical frequencies these would be optical fibres. At microwave frequencies these are empty hollow metal pipes and it is these we shall consider in this section. Examples of waveguide components are shown in Fig. 4.1.

We shall approximate the metal by a perfect conductor, and inside a perfect conductor  $\mathbf{E} = \mathbf{0}$  and  $\mathbf{B} = \mathbf{0}$ , so that the boundary conditions on the electromagnetic fields at the metal surface just outside the conductor are simplified to

$$\mathbf{E}^{\parallel} = \mathbf{0}, \quad \mathbf{B}^{\perp} = \mathbf{0}, \quad (4.1)$$

i.e. the electric field at the surface is normal to the surface, and the magnetic field at the surface is parallel to the surface.

We shall show that the boundary conditions do not allow *transverse electromagnetic* (*TEM*) waves such as those present in empty space to propagate inside a long (length  $L \gg \lambda$ ) narrow (width  $W \lesssim \lambda$ ) hollow metal pipe. Either  $\mathbf{E}$  or  $\mathbf{B}$  must have a longitudinal component for an EM wave to propagate. We can easily prove this by contradiction, i.e. by trying to find a TEM solution for, say, the case of a hollow metal pipe of circular cross section. Remembering that magnetic field lines have no beginning or end, and that the boundary conditions require that the magnetic field at the surface of a (perfect) conductor to be parallel to the surface, I sketch the simplest magnetic field line allowed both by the boundary conditions and by the cylindrical symmetry, and having  $\mathbf{B}$  transverse to the axis of the pipe (Fig. 4.2a).



**Figure 4.2:** A waveguide of circular cross section showing attempts to construct the fields of a TEM wave: (a) a magnetic field allowed by the boundary condition and symmetry, (b) an electric field allowed by the boundary condition and symmetry but ruled out unless there is a central conductor as in part (c).

Remembering that electric field lines start on positive charge, the pipe is empty and the only possible location of charge is on the surface of the conductor, and that the boundary conditions requires the electric field at the surface of the (perfect) conductor to be normal to the surface, I sketch the simplest electric field lines allowed by the boundary conditions and by the cylindrical symmetry while having  $\mathbf{E}$  transverse to both  $\mathbf{B}$  and the axis of the pipe (Fig. 4.2b). There is clearly a problem because electric field lines must end on negative charge but the pipe contains no charge other than on the surface.

The only way to solve the problem while maintaining *both*  $\mathbf{E}$  and  $\mathbf{B}$  transverse to the pipe's axis is to introduce a central conducting wire (Fig. 4.2c), but then we no longer have an *empty* pipe – instead we have a *coaxial cable*. A coaxial cable does act to guide TEM waves, and is therefore strictly speaking a waveguide, but is not what we usually mean by a “waveguide”, i.e. a hollow conducting pipe. Of course one can shine a narrow laser beam along the axis of a metal pipe of large diameter, but in this case the pipe is not actually guiding the laser's TEM wave. What we are really talking about is the impossibility of a TEM wave with coherence width comparable to or larger than the width of the pipe, so that the pipe could be considered as genuinely guiding a monochromatic TEM plane wave along the pipe.

Although our proof was for a pipe of circular cross section, we shall shortly prove that TEM waves can't propagate down a rectangular cross-section pipe, and it can also be proved for long hollow metal pipes of any shape. There must be a component of either the magnetic field or of the electric field along the pipe. If  $\mathbf{B}$  has a component along the waveguide then only  $\mathbf{E}$  is transverse, i.e. we have a *transverse electric (TE)* wave. Similarly, if  $\mathbf{E}$  has a component along the waveguide then only  $\mathbf{B}$  is transverse, i.e. a *transverse magnetic (TM)* wave.

## 4.1 Waves in rectangular waveguides

Rectangular cross-section metal pipes are used to guide EM waves at microwave frequencies, say to or from a transmitting or receiving antenna. We shall consider monochromatic plane waves propagating down a such rectangular cross-section waveguides of infinite length in the  $z$ -direction (Fig. 4.3). The electromagnetic field of a monochromatic EM wave inside the waveguide is of the form

$$\mathbf{E}(x, y, z, t) = \mathbf{E}_0(x, y)e^{i(kz - \omega t)}, \quad \mathbf{B}(x, y, z, t) = \mathbf{B}_0(x, y)e^{i(kz - \omega t)}, \quad (4.2)$$

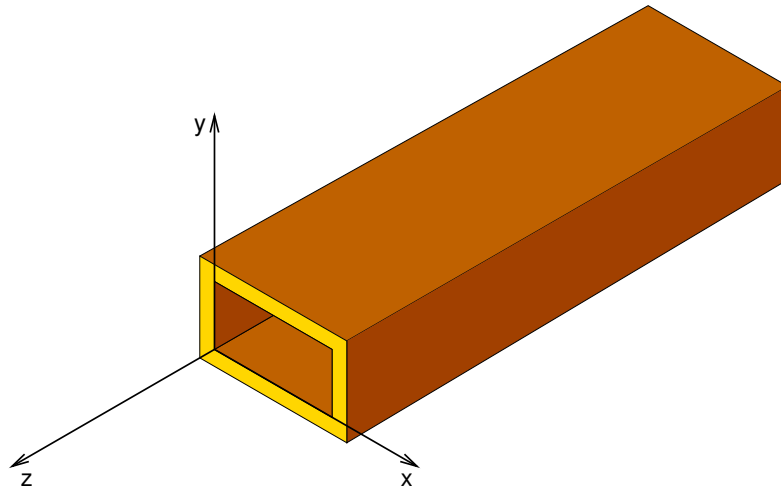


Figure 4.3: Waveguide geometry.

where

$$\mathbf{E}_0(x, y) = E_x^0(x, y)\hat{\mathbf{x}} + E_y^0(x, y)\hat{\mathbf{y}} + E_z^0(x, y)\hat{\mathbf{z}}, \quad (4.3)$$

$$\mathbf{B}_0(x, y) = B_x^0(x, y)\hat{\mathbf{x}} + B_y^0(x, y)\hat{\mathbf{y}} + B_z^0(x, y)\hat{\mathbf{z}}. \quad (4.4)$$

What do you want to do?

No matter what you want out of your future career, an employer with a broad range of operations in a load of countries will always be the ticket. Working within the Volvo Group means more than 100,000 friends and colleagues in more than 185 countries all over the world. We offer graduates great career opportunities – check out the Career section at our web site [www.volvogroup.com](http://www.volvogroup.com). We look forward to getting to know you!

**VOLVO**  
 AB Volvo (publ)  
[www.volvogroup.com](http://www.volvogroup.com)

VOLVO TRUCKS | RENAULT TRUCKS | MACK TRUCKS | VOLVO BUSES | VOLVO CONSTRUCTION EQUIPMENT | VOLVO PENTA | VOLVO AERO | VOLVO IT  
 VOLVO FINANCIAL SERVICES | VOLVO 3P | VOLVO POWERTRAIN | VOLVO PARTS | VOLVO TECHNOLOGY | VOLVO LOGISTICS | BUSINESS AREA ASIA



We need to find what we might call the “field amplitude functions”,  $E_x^0(x, y)$ ,  $E_y^0(x, y)$ ,  $E_z^0(x, y)$ ,  $B_x^0(x, y)$ ,  $B_y^0(x, y)$  and  $B_z^0(x, y)$ , that specify the EM field at  $(x, y, z = 0)$  at time  $t = 0$  that satisfy Maxwell’s equations inside the waveguide as well as the boundary conditions on the EM field at the conducting surface.

Putting Eqs. 4.2 into Faraday’s law,

$$\nabla \times \mathbf{E} = -\frac{\partial \mathbf{B}}{\partial t}, \quad (4.5)$$

for  $e^{-i\omega t}$  time-dependence and  $e^{ikz}$   $z$ -dependence Faraday’s law gives

$$\frac{\partial E_z}{\partial y} - \frac{\partial E_y}{\partial z} = -\frac{\partial B_x}{\partial t} \quad \Rightarrow \quad \frac{\partial E_z^0}{\partial y} - ikE_y^0 = i\omega B_x^0, \quad (4.6)$$

$$\frac{\partial E_x}{\partial z} - \frac{\partial E_z}{\partial x} = -\frac{\partial B_y}{\partial t} \quad \Rightarrow \quad ikE_x^0 - \frac{\partial E_z^0}{\partial x} = i\omega B_y^0, \quad (4.7)$$

$$\frac{\partial E_y}{\partial x} - \frac{\partial E_x}{\partial y} = -\frac{\partial B_z}{\partial t} \quad \Rightarrow \quad \frac{\partial E_y^0}{\partial x} - \frac{\partial E_x^0}{\partial y} = i\omega B_z^0. \quad (4.8)$$

Putting Eqs. 4.2 into Ampere’s law for empty space,

$$\nabla \times \mathbf{B} = \frac{1}{c^2} \frac{\partial \mathbf{E}}{\partial t}, \quad (4.9)$$

for  $e^{-i\omega t}$  time-dependence and  $e^{ikz}$   $z$ -dependence Ampere’s law gives

$$\frac{\partial B_z}{\partial y} - \frac{\partial B_y}{\partial z} = \frac{1}{c^2} \frac{\partial E_x}{\partial t} \quad \Rightarrow \quad \frac{\partial B_z^0}{\partial y} - ikB_y^0 = \frac{-i\omega}{c^2} E_x^0, \quad (4.10)$$

$$\frac{\partial B_x}{\partial z} - \frac{\partial B_z}{\partial x} = \frac{1}{c^2} \frac{\partial E_y}{\partial t} \quad \Rightarrow \quad ikB_x^0 - \frac{\partial B_z^0}{\partial x} = \frac{-i\omega}{c^2} E_y^0, \quad (4.11)$$

$$\frac{\partial B_y}{\partial x} - \frac{\partial B_x}{\partial y} = \frac{1}{c^2} \frac{\partial E_z}{\partial t} \quad \Rightarrow \quad \frac{\partial B_y^0}{\partial x} - \frac{\partial B_x^0}{\partial y} = \frac{-i\omega}{c^2} E_z^0. \quad (4.12)$$

Equations 4.6 and 4.11 give

$$E_y^0 = \left( \frac{\partial E_z^0}{\partial y} - i\omega B_x^0 \right) (ik)^{-1}, \quad (4.13)$$

$$E_y^0 = \left( ikB_x^0 - \frac{\partial B_z^0}{\partial x} \right) \left( -\frac{i\omega}{c^2} \right)^{-1}, \quad (4.14)$$

from which we can eliminate  $E_y^0$  to obtain  $B_x^0$ ,

$$B_x^0 = \frac{i}{(\omega/c)^2 - k^2} \left( k \frac{\partial B_z^0}{\partial x} - \frac{\omega}{c^2} \frac{\partial E_z^0}{\partial y} \right). \quad (4.15)$$

Similarly, one can show that

$$B_y^0 = \frac{i}{(\omega/c)^2 - k^2} \left( k \frac{\partial B_z^0}{\partial y} + \frac{\omega}{c^2} \frac{\partial E_z^0}{\partial x} \right), \quad (4.16)$$

$$E_x^0 = \frac{i}{(\omega/c)^2 - k^2} \left( k \frac{\partial E_z^0}{\partial x} + \omega \frac{\partial B_z^0}{\partial y} \right), \quad (4.17)$$

$$E_y^0 = \frac{i}{(\omega/c)^2 - k^2} \left( k \frac{\partial E_z^0}{\partial y} - \omega \frac{\partial B_z^0}{\partial x} \right). \quad (4.18)$$

Thus, if we know the longitudinal fields we can obtain the transverse fields.

We have already shown that TEM waves cannot occur in a hollow circular cross-section waveguide. We are now in a position to prove that TEM waves are also impossible in a rectangular cross-section waveguide. Putting both  $E_z^0 = 0$  and  $B_z^0 = 0$  into Eqs. 4.15–4.18 gives  $B_x^0 = B_y^0 = 0$  and  $E_x^0 = E_y^0 = 0$ , proving that unless there is a longitudinal component of  $\mathbf{E}$  or  $\mathbf{B}$  that there will be no EM wave inside the waveguide.

## 4.2 Waveguide modes

Putting Eqs. 4.2 into Gauss's law in empty space,  $\nabla \cdot \mathbf{E} = 0$ , we obtain

$$\frac{\partial E_x^0}{\partial x} + \frac{\partial E_y^0}{\partial y} + ikE_z^0 = 0 \quad (4.19)$$

Next, substituting Eqs. 4.17 and 4.18 we obtain

$$\begin{aligned} & \frac{i}{(\omega/c)^2 - k^2} \left( k \frac{\partial^2 E_z^0}{\partial x^2} + \omega \frac{\partial^2 B_z^0}{\partial x \partial y} \right) \\ & + \frac{i}{(\omega/c)^2 - k^2} \left( k \frac{\partial^2 E_z^0}{\partial y^2} - \omega \frac{\partial^2 B_z^0}{\partial y \partial x} \right) + ikE_z^0 = 0, \end{aligned} \quad (4.20)$$

$$\therefore \left( \frac{\partial^2}{\partial x^2} + \frac{\partial^2}{\partial y^2} + (\omega/c)^2 - k^2 \right) E_z^0 = 0. \quad (4.21)$$

Similarly, putting Eqs. 4.2 into  $\nabla \cdot \mathbf{B} = 0$  and substituting Eqs. 4.15 and 4.16 yields

$$\left( \frac{\partial^2}{\partial x^2} + \frac{\partial^2}{\partial y^2} + (\omega/c)^2 - k^2 \right) B_z^0 = 0. \quad (4.22)$$

Only two types of EM wave are possible in a waveguide: TM (“transverse magnetic”) with  $E_z = 0$ , and TE (“transverse electric”) with  $B_z = 0$  — to find their allowed EM fields we will need to solve Eqs. 4.21 and 4.22, respectively.

**gaiTeye**<sup>®</sup>  
Challenge the way we run

**EXPERIENCE THE POWER OF FULL ENGAGEMENT...**

**RUN FASTER.  
RUN LONGER..  
RUN EASIER...**

**READ MORE & PRE-ORDER TODAY  
WWW.GAITEYE.COM**



### 4.2.1 TM modes

TM waves have  $B_z = 0$  and  $E_z \neq 0$ . We can solve Eq. 4.21 for  $E_z^0(x, y)$  by the method of separation of variables. We seek a solution of the form

$$E_z^0(x, y) = X(x)Y(y) \quad (4.23)$$

and substitute it into Eq. 4.22 to get

$$Y \frac{\partial^2 X}{\partial x^2} + X \frac{\partial^2 Y}{\partial y^2} + [(\omega/c)^2 - k^2]XY = 0, \quad (4.24)$$

$$\therefore \frac{1}{X} \frac{\partial^2 X}{\partial x^2} + \frac{1}{Y} \frac{\partial^2 Y}{\partial y^2} + [(\omega/c)^2 - k^2] = 0. \quad (4.25)$$

Since the 1st term depends only on  $x$ , and the 2nd term depends only on  $y$ , each term must be constant such that

$$\frac{1}{X} \frac{\partial^2 X}{\partial x^2} = -\kappa_x^2, \quad (4.26)$$

$$\frac{1}{Y} \frac{\partial^2 Y}{\partial y^2} = -\kappa_y^2, \quad (4.27)$$

and

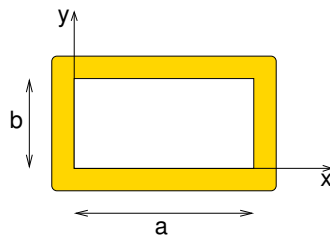
$$-\kappa_x^2 - \kappa_y^2 + [(\omega/c)^2 - k^2] = 0. \quad (4.28)$$

Equations 4.26 and 4.27 have sinusoidal solutions for  $X(x)$  and  $Y(y)$  of the form

$$X(x) = F \sin(\kappa_x x) + G \cos(\kappa_x x), \quad (4.29)$$

$$Y(y) = \mathcal{F} \sin(\kappa_y y) + \mathcal{G} \cos(\kappa_y y). \quad (4.30)$$

We now need to find allowed values of  $F$ ,  $G$ ,  $\mathcal{F}$ ,  $\mathcal{G}$ ,  $\kappa_x$  and  $\kappa_y$  from the boundary conditions on the electric field at the surface of the conductor  $\mathbf{E}^{\parallel} = \mathbf{0}$  (Eqs. 4.1), i.e. at  $x = 0$ ,  $x = a$ ,  $y = 0$



**Figure 4.4:** Cross-section of rectangular waveguide with width  $a$  and height  $b$ .

and  $y = b$  in Fig. 4.4. This condition is satisfied by  $G = \mathcal{G} = 0$  and

$$E_z^0(x, y) = E_{mn} \sin\left(\frac{m\pi x}{a}\right) \sin\left(\frac{n\pi y}{b}\right) \quad \text{for } m = 1, 2, 3, \dots \text{ and } n = 1, 2, 3, \dots \quad (4.31)$$

This solution gives the amplitude function of  $E_z$  for the  $\text{TM}_{mn}$  mode; the 1st index  $m$  by convention is associated with the larger dimension and the 2nd  $n$  with the smaller dimension. We have now obtained the solution of Eq. 4.21 for TM waves. Note that the lowest possible TM mode is  $\text{TM}_{11}$ .

#### 4.2.2 TE modes

TE waves have  $E_z = 0$  and  $B_z \neq 0$ . We can solve Eq. 4.22 for  $B_z^0(x, y)$  by the method of separation of variables

$$B_z^0(x, y) = X(x)Y(y) \quad (4.32)$$

as for the case of the TM modes, and with the same form for the solutions  $X(x)$  and  $Y(y)$  (as given by Eqs. 4.29 and 4.30). We now need to find allowed values of  $F$ ,  $G$ ,  $\mathcal{F}$ ,  $\mathcal{G}$ ,  $\kappa_x$  and  $\kappa_y$  for TE modes from the boundary conditions on the magnetic field at the surface of the conductor  $\mathbf{B}^\perp = 0$  (Eqs. 4.1), i.e. at  $x = 0$ ,  $x = a$ ,  $y = 0$  and  $y = b$  in Fig. 4.4.

Since the waveguide is aligned along the  $z$  direction the  $z$ -component of  $\mathbf{B}$  is always parallel to the conducting surface and so  $\mathbf{B}^\perp = 0$  is always satisfied by  $B_z$ . To get a useful constraint on  $X(x)$  we must instead use  $B_x$  with  $B_x^0(0, y) = B_x^0(a, y) = 0$  as required by  $\mathbf{B}^\perp = 0$ . Eq. 4.15 gives  $B_x^0$  in terms of  $B_z^0$  and  $E_z^0$ , but since for TE waves  $E_z = 0$  we obtain

$$B_x^0(x, y) = \left( \frac{ik}{(\omega/c)^2 - k^2} \right) \frac{\partial B_z^0(x, y)}{\partial x}. \quad (4.33)$$

Hence,

$$\frac{\partial B_z^0(x, y)}{\partial x} = 0 \quad (\text{at } x = 0 \text{ and } x = a), \quad (4.34)$$

and differentiating Eq. 4.29 with respect to  $x$  we obtain

$$\kappa_x F \cos(\kappa_x x) - \kappa_x G \sin(\kappa_x x) = 0 \quad (\text{at } x = 0 \text{ and } x = a) \quad (4.35)$$

which requires  $F = 0$  and  $\kappa_x = m\pi/a$  for  $m = 0, 1, 2, \dots$

Similarly, To get a useful constraint on  $Y(y)$  we must instead use  $B_y$  with  $B_y^0(0, y) = B_y^0(b, y) = 0$ , and Eq. 4.16 which gives  $B_y^0$  in terms of  $B_z^0$  and  $E_z^0$  (0 for TE waves). The result is that  $\mathcal{F} = 0$  and  $\kappa_y = n\pi/b$  for  $n = 0, 1, 2, \dots$ . We have now obtained the solution of Eq. 4.22 for TE waves

$$B_z^0(x, y) = B_{mn} \cos\left(\frac{m\pi x}{a}\right) \cos\left(\frac{n\pi y}{b}\right) \quad \text{for } m = 0, 1, 2, \dots \text{ and } n = 0, 1, 2, \dots \quad (4.36)$$

This e-book  
is made with  
**SetaPDF**





**SETASIGN**

PDF components for **PHP** developers

[www.setasign.com](http://www.setasign.com)

Note that either  $m > 0$  or  $n > 0$  otherwise  $B_z^0(x, y)$  is constant and Eqs. 4.15–4.18 yield  $E_x^0 = E_y^0 = B_x^0 = B_y^0 = 0$ . Eq. 4.36 gives the amplitude function of  $B_z$  for the  $\text{TE}_{mn}$  mode. We have now obtained the solution of Eq. 4.22 for TE waves.

### 4.3 Dispersion relation, phase and group velocities

We can find the dispersion relation from Eq. 4.28

$$k^2 c^2 = \omega^2 - \kappa_x^2 c^2 - \kappa_y^2 c^2 \quad (4.37)$$

$$\therefore kc = \sqrt{\omega^2 - \omega_{mn}^2} \quad (4.38)$$

where

$$\omega_{mn} \equiv c\pi \sqrt{\left(\frac{m}{a}\right)^2 + \left(\frac{n}{b}\right)^2}. \quad (4.39)$$

If  $\omega < \omega_{mn}$  the wave number is imaginary, and the  $\text{TE}_{mn}$  and  $\text{TM}_{mn}$  waves do not propagate (they die off exponentially), so  $\omega_{mn}$  is the cut-off frequency for the  $\text{TE}_{mn}$  and  $\text{TM}_{mn}$  modes. Since there is no  $\text{TM}_{10}$ , the lowest cut-off frequency occurs for the  $\text{TE}_{10}$  mode and is  $\omega_{10} = c\pi/a$ . The complete EM fields for the TE and TM modes are given in Appendix 4.36.

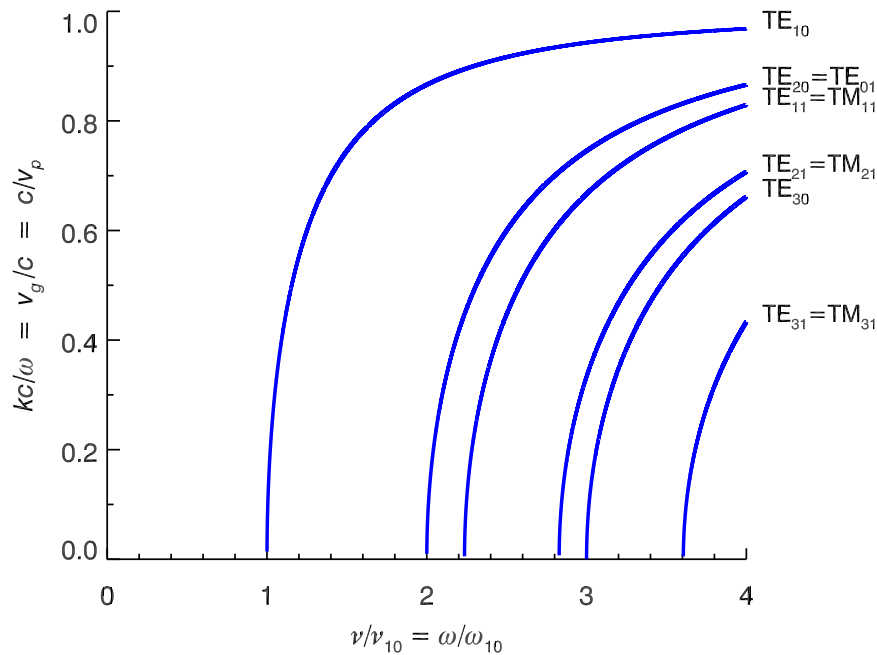
The phase and group velocities for TE and TM modes are

$$v_p = \frac{\omega}{k} = \frac{c}{\sqrt{1 - (\omega_{mn}/\omega)^2}} > c, \quad (4.40)$$

$$v_g = \frac{1}{dk/d\omega} = c\sqrt{1 - (\omega_{mn}/\omega)^2} < c, \quad (4.41)$$

and they are plotted in Fig. 4.5. Note that  $v_g/c = c/v_p$  (similar to a dilute plasma).

When using a waveguide to transmit a signal at a given frequency, it is important that only one waveguide mode is excited otherwise more than one copy of the signal will propagate along the waveguide, each with a different velocity. From Fig. 4.5 we see that this can be accomplished if the frequency is between  $\nu_{10}$  and  $\nu_{20}$ . Waveguides with different widths are therefore designed for use at different frequencies, e.g. a standard waveguide for the “X-band” (8.2–12.4 GHz) has internal cross section 2.286 cm by 1.143 cm.



**Figure 4.5:** The first few modes of a rectangular waveguide with  $a = 2b$ .

#### 4.4 The EM field and power transmitted for TE<sub>10</sub> mode

For all the TE modes the amplitude function of the longitudinal component of the magnetic field is given by Eq. 4.36. We can get all the other field amplitude functions from  $B_z^0(x, y)$  and  $E_z^0(x, y) = 0$  using Eqs. 4.15—4.18, and then multiplying by  $\exp[i(kz(\omega) - \omega t)]$  to get the (complex) EM field, and finally taking the real part. In this way one can find the non-zero EM field components of a TE<sub>10</sub> wave travelling in the  $z$ -direction:

$$E_y = -B_{10} \omega \left(\frac{a}{\pi}\right) \sin\left(\frac{\pi x}{a}\right) \sin(kz - \omega t) = E_{\max} \sin\left(\frac{\pi x}{a}\right) \sin(kz - \omega t), \quad (4.42)$$

$$B_x = B_{10} k \left(\frac{a}{\pi}\right) \sin\left(\frac{\pi x}{a}\right) \sin(kz - \omega t) = -E_{\max} \frac{k}{\omega} \sin\left(\frac{\pi x}{a}\right) \sin(kz - \omega t), \quad (4.43)$$

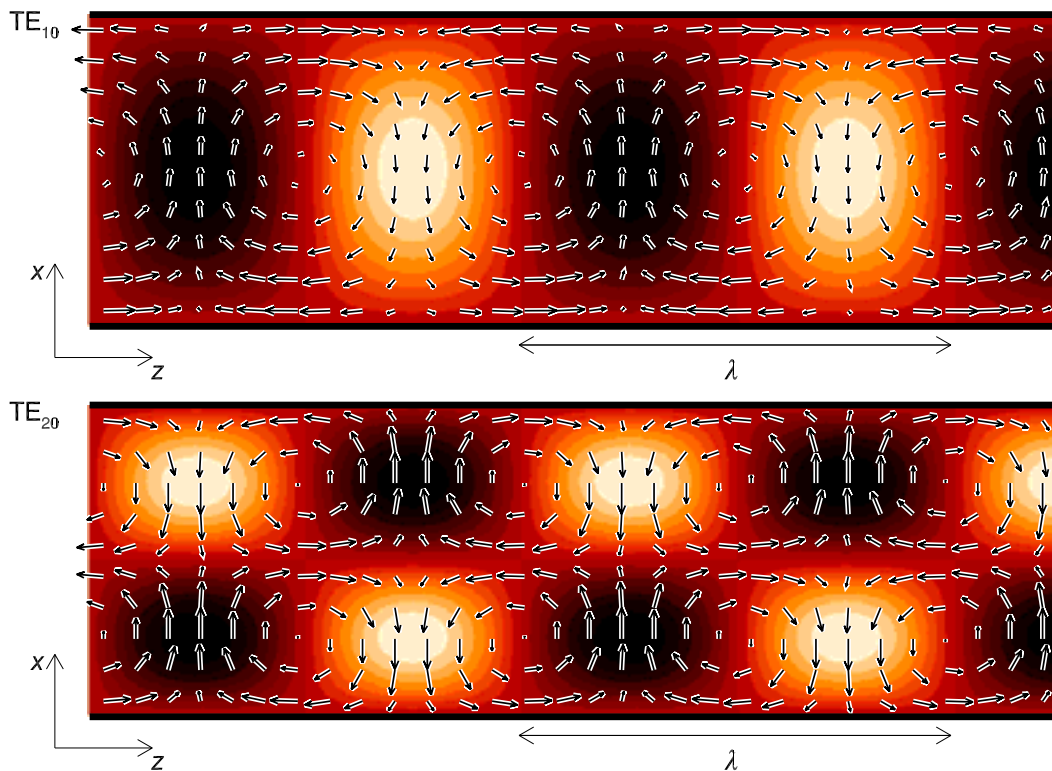
$$B_z = B_{10} \cos\left(\frac{\pi x}{a}\right) \cos(kz - \omega t) = -E_{\max} \frac{\pi}{a\omega} \cos\left(\frac{\pi x}{a}\right) \cos(kz - \omega t). \quad (4.44)$$

where

$$k = \sqrt{\omega^2/c^2 - (\pi/a)^2}, \quad E_{\max} = -B_{10} \frac{\omega a}{\pi}. \quad (4.45)$$

The electric and magnetic fields for the other TE modes, and for the TM modes, can be obtained in a similar way from  $E_z^0(x, y)$  and  $B_z^0 = 0$ . The electric and magnetic fields for all TE and TM modes are given in Appendix D, and for example, Fig. 4.6 shows the field configuration for TE<sub>10</sub> and TE<sub>20</sub> waves travelling in the  $\hat{z}$  direction. It is straightforward to show (Exercise 4-2) that the energy density per unit length of waveguide for the TE<sub>10</sub> mode is

$$\frac{U}{L} = \frac{\varepsilon_0 ab}{4} E_{\max}^2. \quad (4.46)$$



**Figure 4.6:** The electric field and magnetic field configurations of TE<sub>10</sub> and TE<sub>20</sub> waves travelling in the  $\hat{z}$  direction. The electric field is in the  $\pm\hat{y}$  direction and the colour image shows its amplitude (black corresponds to  $\mathbf{E} = -E_{\max}\hat{y}$  and white to  $\mathbf{E} = +E_{\max}\hat{y}$ ). The magnetic field direction and strength is shown by the vectors.

The Poynting vector is

$$\mathbf{S}(\mathbf{r}, t) = \mathbf{E}(\mathbf{r}, t) \times \mathbf{H}(\mathbf{r}, t), \quad (4.47)$$

$$= [E_y(\mathbf{r}, t)\hat{\mathbf{y}}] \times \frac{1}{\mu_0} [B_x(\mathbf{r}, t)\hat{\mathbf{x}} + B_z(\mathbf{r}, t)\hat{\mathbf{z}}], \quad (4.48)$$

$$= \frac{1}{\mu_0} [-E_y(\mathbf{r}, t)B_x(\mathbf{r}, t)\hat{\mathbf{z}} + E_y(\mathbf{r}, t)B_z(\mathbf{r}, t)\hat{\mathbf{x}}], \quad (4.49)$$

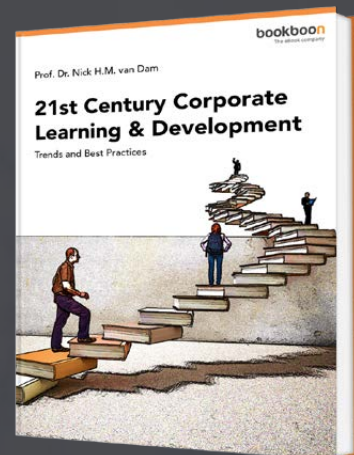
$$= \frac{1}{\mu_0} \left[ \frac{v_g}{c^2} E_{\max}^2 \sin^2\left(\frac{\pi x}{a}\right) \sin^2(kz - \omega t) \hat{\mathbf{z}} - \frac{\pi}{2a\omega} E_{\max}^2 \sin\left(\frac{2\pi x}{a}\right) \sin[2(kz - \omega t)] \hat{\mathbf{x}} \right], \quad (4.50)$$

$$\therefore \mathbf{S}(\mathbf{r}, t) = v_g \varepsilon_0 E_{\max}^2 \sin^2\left(\frac{\pi x}{a}\right) \sin^2(kz - \omega t) \hat{\mathbf{z}} - \frac{1}{\mu_0} \frac{\pi}{2a\omega} E_{\max}^2 \sin\left(\frac{2\pi x}{a}\right) \sin[2(kz - \omega t)] \hat{\mathbf{x}}, \quad (4.51)$$

# Free eBook on Learning & Development

By the Chief Learning Officer of McKinsey

[Download Now](#)



$$\therefore \langle \mathbf{S}(\mathbf{r}) \rangle = v_g \frac{\varepsilon_0}{2} E_{\max}^2 \sin^2 \left( \frac{\pi x}{a} \right) \hat{\mathbf{z}}, \quad (4.52)$$

with  $v_g = c^2 k / \omega$  and  $k = \sqrt{\omega^2 / c^2 - (\pi/a)^2}$ . Note also that we have used  $\sin \theta \cos \theta = \frac{1}{2} \sin(2\theta)$  above.

The power transmitted is the integral of the flux of  $\langle \mathbf{S} \rangle$  over the cross-sectional area of the waveguide

$$P = \int_0^a \int_0^b v_g \frac{\varepsilon_0}{2} E_{\max}^2 \sin^2 \left( \frac{\pi x}{a} \right) dy dx, \quad (4.53)$$

$$= b v_g \frac{\varepsilon_0}{2} E_{\max}^2 \int_0^a \sin^2 \left( \frac{\pi x}{a} \right) dx. \quad (4.54)$$

$$\therefore P = a b v_g \frac{\varepsilon_0}{4} E_{\max}^2. \quad (4.55)$$

Notice that this is just the energy per unit length (Eq. 4.46) multiplied by the group velocity, and we see that the energy propagates along waveguide at  $v_g$ , as expected.

## Summary of important concepts and equations

### Boundary conditions at the surface of a perfect conductor ( $\mathbf{E}_{\parallel} = 0$ , $\mathbf{B}_{\perp} = 0$ )

- Forbid transverse electromagnetic (TEM) waves which have  $\mathbf{B} \cdot \mathbf{k} = 0$  and  $\mathbf{E} \cdot \mathbf{k} = 0$
- Allow transverse electric (TE) waves which have  $\mathbf{E} \cdot \mathbf{k} = 0$  and  $\mathbf{B} \cdot \mathbf{k} \neq 0$
- Allow transverse magnetic (TM) waves which have  $\mathbf{B} \cdot \mathbf{k} = 0$  and  $\mathbf{E} \cdot \mathbf{k} \neq 0$

### Field of a monochromatic EM wave inside rectangular waveguide ( $\mathbf{k} = k\hat{\mathbf{z}}$ )

$$\mathbf{E}(x, y, z, t) = \mathbf{E}_0(x, y) e^{i(kz - \omega t)}, \quad \mathbf{B}(x, y, z, t) = \mathbf{B}_0(x, y) e^{i(kz - \omega t)}.$$

- Field amplitude functions  $\mathbf{E}_0(x, y)$  and  $\mathbf{B}_0(x, y)$  can be found by substitution into Maxwell's equations in differential form and applying the boundary conditions.



- Using Faraday's and Ampere's laws we get equations for the  $x$  and  $y$  components of  $\mathbf{E}_0(x, y)$  and  $\mathbf{B}_0(x, y)$  in terms of the  $z$  components.
- Using  $\nabla \cdot \mathbf{E} = 0$  and  $\nabla \cdot \mathbf{B} = 0$  we obtain partial differential equations for the  $z$  components of  $\mathbf{E}_0(x, y)$  and  $\mathbf{B}_0(x, y)$  which are solved by separation of variables.
- Applying boundary conditions give the solutions for  $\text{TM}_{mn}$  and  $\text{TE}_{mn}$  modes

$$\text{TM: } E_z^0(x, y) = E_{mn} \sin\left(\frac{m\pi x}{a}\right) \sin\left(\frac{n\pi y}{b}\right), \quad (m = 1, 2, 3, \dots; n = 1, 2, 3, \dots),$$

$$\text{TE: } B_z^0(x, y) = B_{mn} \cos\left(\frac{m\pi x}{a}\right) \cos\left(\frac{n\pi y}{b}\right), \quad (m = 0, 1, 2, \dots; n = 0, 1, 2, \dots).$$

### Dispersion relation, phase and group velocities

$$kc = \sqrt{\omega^2 - \omega_{mn}^2}, \quad \omega_{mn} \equiv c\pi \sqrt{\left(\frac{m}{a}\right)^2 + \left(\frac{n}{b}\right)^2}.$$

- $\omega_{mn}$  is the cut-off frequency for the  $\text{TE}_{mn}$  and  $\text{TM}_{mn}$  modes.



www.sylvania.com

**We do not reinvent the wheel we reinvent light.**

Fascinating lighting offers an infinite spectrum of possibilities: Innovative technologies and new markets provide both opportunities and challenges. An environment in which your expertise is in high demand. Enjoy the supportive working atmosphere within our global group and benefit from international career paths. Implement sustainable ideas in close cooperation with other specialists and contribute to influencing our future. Come and join us in reinventing light every day.

Light is OSRAM

**OSRAM SYLVANIA** 

- The lowest cut-off frequency occurs for the  $\text{TE}_{10}$  mode and is  $\omega_{10} = c\pi/a$ .
- The phase and group velocities for TE and TM modes are

$$v_p = \frac{\omega}{k} = \frac{c}{\sqrt{1 - (\omega_{mn}/\omega)^2}} > c,$$

$$v_g = \frac{1}{dk/d\omega} = c\sqrt{1 - (\omega_{mn}/\omega)^2} < c.$$

### Exercises on Chapter 4

- 4–1 A standard waveguide for the “X-band” (8.2–12.4 GHz) has internal cross section 2.286 cm by 1.143 cm. Find the the first two cut-off frequencies, as these will give the frequency range for which only the  $\text{TE}_{10}$  mode will propagate.
- 4–2 Find the electromagnetic field energy per unit length of waveguide for  $\text{TE}_{10}$  mode. Express your result in terms of  $ab\epsilon_0 E_{\max}^2$ . Start with the fields for the  $\text{TE}_{10}$  mode

$$E_y = E_{\max} \sin\left(\frac{\pi x}{a}\right) \sin(kz - \omega t), \quad (4.56)$$

$$B_x = -E_{\max} \frac{k}{\omega} \sin\left(\frac{\pi x}{a}\right) \sin(kz - \omega t), \quad (4.57)$$

$$B_z = -E_{\max} \frac{\pi}{a\omega} \cos\left(\frac{\pi x}{a}\right) \cos(kz - \omega t). \quad (4.58)$$

where  $k = \sqrt{\omega^2/c^2 - (\pi/a)^2}$ .

- 4–3 Consider a hollow standard WR-159 F-band waveguide which has an internal cross section of 40.386 mm  $\times$  20.193 mm.
- (a) A 2 GHz signal is fed into the waveguide. Will this cause a wave to propagate along the waveguide?
- (b) Assuming the wave would be in the  $\text{TE}_{10}$  mode, what is the wavenumber? Discuss the implications of your answer.
- 4–4 Consider the case of launching an EM wave with frequency  $\omega < \omega_{10}$  into a rectangular waveguide. Assuming the wave will attempt to propagate as a  $\text{TE}_{10}$  wave travelling in along the waveguide (in the  $z$  direction),
- (a) Derive all the components of the electromagnetic field for the case where  $k$  is purely imaginary.
- (b) Obtain the Poynting vector and discuss the energy flow.

## 5 Radiation and scattering

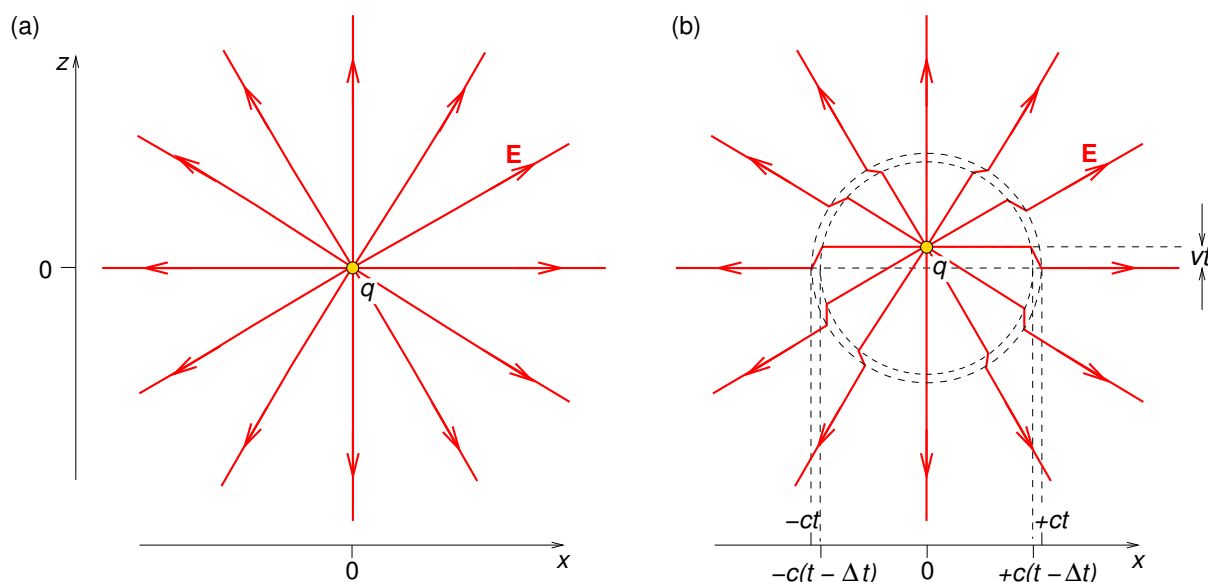
### Learning objectives

- To understand that an accelerated charge radiates, and to be able to obtain Larmor's formula which gives instantaneous power  $P = \frac{a^2 q^2}{6\pi\epsilon_0 c^3}$ .
- To be able to derive the time-averaged power radiated by an oscillating dipole  $\mathbf{p}(t) = p_0 \cos(\omega t)\hat{\mathbf{z}}$ , and its radiation pattern  $\langle \frac{dP}{d\Omega} \rangle = \frac{p_0^2 \omega^4 \sin^2 \theta}{32\pi^2 \epsilon_0 c^3}$  showing the characteristic  $\sin^2 \theta$  dependence.
- To be able to show that a short centre-fed dipole antenna (total length  $d \ll \lambda$ ) behaves as an oscillating electric dipole, but know that half-wave antennas with  $d = \lambda/2$  are more efficient radiators and have radiation patterns which resemble the standard dipole pattern.
- To understand that EM waves incident on a particle (or small object) will produce oscillating charges or currents causing some of the incident radiation to be scattered (i.e. absorbed and re-radiated).
- To learn that the total cross section for scattering of EM waves is the time-averaged power re-radiated divided by the time-averaged incident energy flux, and that for free electrons acceleration and re-radiation according to Larmor's formula leads to Thomson cross section for scattering of EM radiation or photons with frequencies  $\nu \ll m_e c^2/h$  by free electrons
- To know that for a molecule, an EM wave induces an oscillating molecular dipole  $\alpha_m \mathbf{E}(t)$  and a cross section which is proportional to  $\lambda^{-4}$  thereby explaining why the sky is blue and sunsets are red.
- To be able to derive the inhomogeneous wave equations for the potentials, their retarded potential solutions and to derive the vector potential for sinusoidal sources.
- To be able to apply the retarded potential solutions in the far zone to obtain the vector potential and EM field for a long antenna.

Whenever you accelerate a charge it radiates EM radiation. Electrons oscillating up and down an antenna are being accelerated and radiate radio waves. In an atom in transition from one quantum state to another there is a superposition of the two states with the electron's probability density oscillating and changing shape at a frequency equal to the difference in energy levels divided by Planck's constant, the result being the emission or absorption of a photon.

## 5.1 Larmor's formula

Consider a stationary isolated point charge  $+q$  at the origin. Its electric field lines extend radially outward isotropically to infinity as shown in Fig. 5.1(a). Suppose at time  $t = 0$  we accelerated that charge with acceleration  $\mathbf{a} = a\hat{\mathbf{z}}$  for an infinitesimal time interval  $\Delta t$  such that it acquires velocity  $\mathbf{v} = v\hat{\mathbf{z}}$  much less than the speed of light  $v \ll c$ .

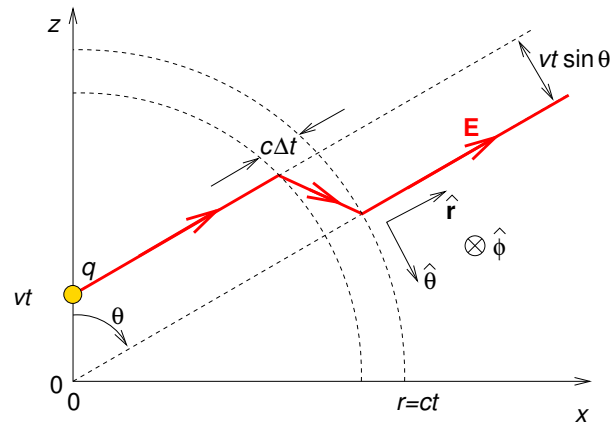


**Figure 5.1:** (a) Electric field lines of stationary point charge  $+q$  located at the origin. (b) Electric field lines of the charge at time  $t$  after it has been accelerated during an infinitesimal time interval from  $t = 0$  to  $t = \Delta t$ , after which it reached velocity  $\mathbf{v} = v\hat{\mathbf{z}}$  where  $v \ll c$ .

Because information cannot be transmitted faster than light, if we look at the charge at time  $t$ , when it has moved to position  $\mathbf{r} = vt\hat{\mathbf{z}}$  (Fig. 5.1b), we would see that at a distance  $r > ct$  from the origin the electric field lines would be *identical* to those of the charge before it had been accelerated. However, because  $v \ll c$ , within distance  $r < c(t - \Delta t)$  from the origin, the electric field lines at time  $t$  would closely resemble those of a *stationary* charge  $+q$  located at  $\mathbf{r} = vt\hat{\mathbf{z}}$ . The field lines inside radius  $c(t - \Delta t)$  must join up with those outside radius  $ct$ . This takes place in the spherical shell between  $c(t - \Delta t) < r < ct$  where there will be a kink in the field lines which propagates outwards from the origin as a spherical wave travelling at speed  $c$ .

By taking a close-up look at one of the field lines in the vicinity of the kink (Fig. 5.2), i.e. in the spherical shell between  $c(t - \Delta t) < r < ct$ , we find that

$$\frac{E_\theta}{E_r} = \frac{vt \sin \theta}{c\Delta t} = \frac{(a\Delta t)(r/c) \sin \theta}{c\Delta t} = a \frac{r}{c^2} \sin \theta. \quad (5.1)$$



**Figure 5.2:** Enlargement of one of the electric field lines of the charge at time  $t$  after it has been accelerated for a short time interval from  $t = 0$  to  $(t + \Delta t)$  after which it reached velocity  $\mathbf{v} = v\hat{\mathbf{z}}$  where  $v \ll c$ .

where  $a = v/\Delta t$  is the acceleration. The radial component of  $\mathbf{E}$  is given by Coulomb's law,



Discover the truth at [www.deloitte.ca/careers](http://www.deloitte.ca/careers)

**Deloitte.**

© Deloitte & Touche LLP and affiliated entities.



$E_r = q/4\pi\epsilon_0 r^2$ . Hence

$$E_\theta = a \frac{r}{c^2} \sin \theta \frac{q}{4\pi\epsilon_0 r^2} = \frac{aq \sin \theta}{4\pi\epsilon_0 r c^2}. \quad (5.2)$$

Notice that  $E_\theta \propto 1/r$  dominates over  $E_r \propto 1/r^2$  at large  $r$ . For  $c\Delta t \ll vt$ ,  $\mathbf{E} \approx E_\theta \hat{\boldsymbol{\theta}}$  where the field is kinked, and so the electric field is perpendicular to the direction of propagation of the kink which is in the  $\hat{\mathbf{r}}$  direction. This is characteristic of electromagnetic waves which have  $\mathbf{k} \cdot \mathbf{E} = 0$ .

There will also be an azimuthal magnetic field in the spherical shell corresponding to  $c(t - \Delta t) < r < ct$  that drops off like  $B_\phi \propto 1/r$  and is due to the current density associated with the motion of the charge which before  $t = 0$  had  $\mathbf{v} = \mathbf{0}$  and after  $t = \Delta t$  had velocity  $\mathbf{v} = a\Delta t \hat{\mathbf{z}}$ . In fact, within the kink region,

$$\mathbf{E} = \frac{aq \sin \theta}{4\pi\epsilon_0 r c^2} \hat{\boldsymbol{\theta}}; \quad \mathbf{B} = \frac{E_\theta}{c} \hat{\boldsymbol{\phi}}. \quad (5.3)$$

Since  $\mathbf{E} = E \hat{\boldsymbol{\theta}}$  the wave is linearly polarised in the  $\hat{\boldsymbol{\theta}}$  direction, i.e. the plane containing the acceleration direction ( $\hat{\mathbf{z}}$ ) and the wave vector's direction ( $\hat{\mathbf{r}}$ ).

### 5.1.1 Total power

The energy flux is given by the Poynting vector which for EM waves in empty space is given by

$$\mathbf{S} = \epsilon_0 E_\theta^2 \hat{\mathbf{r}} = \epsilon_0 \left( \frac{aq \sin \theta}{4\pi\epsilon_0 r c^2} \right)^2 \hat{\mathbf{r}} = \frac{a^2 q^2 \sin^2 \theta}{(4\pi)^2 \epsilon_0 r^2 c^3} \hat{\mathbf{r}}, \quad (5.4)$$

Note the dependence on  $a^2$ ,  $q^2$ ,  $\sin^2 \theta$  and the  $1/r^2$  inverse square law dependence. The solid angle subtended at the origin by  $d(\text{area})$  perpendicular to  $\hat{\mathbf{r}}$  is  $d\Omega = d(\text{area})/r^2$ . Hence, the power emitted during the acceleration per unit solid angle is

$$\frac{dP}{d\Omega} = \frac{a^2 q^2 \sin^2 \theta}{(4\pi)^2 \epsilon_0 c^3}. \quad (5.5)$$

The total instantaneous radiation power is

$$P = \oint \frac{dP}{d\Omega} d\Omega = \int_{-1}^1 \frac{a^2 q^2 \sin^2 \theta}{(4\pi)^2 \epsilon_0 c^3} 2\pi d(\cos \theta) = \frac{a^2 q^2}{6\pi \epsilon_0 c^3}, \quad (5.6)$$

which is *Larmor's radiation formula*, named after British physicist Sir Joseph Larmor (1857–1942) who derived it in 1897, and is valid for  $v \ll c$ . The restriction on  $v$  is not usually a problem as one can often Lorentz transform to a frame in which  $v = 0$ .

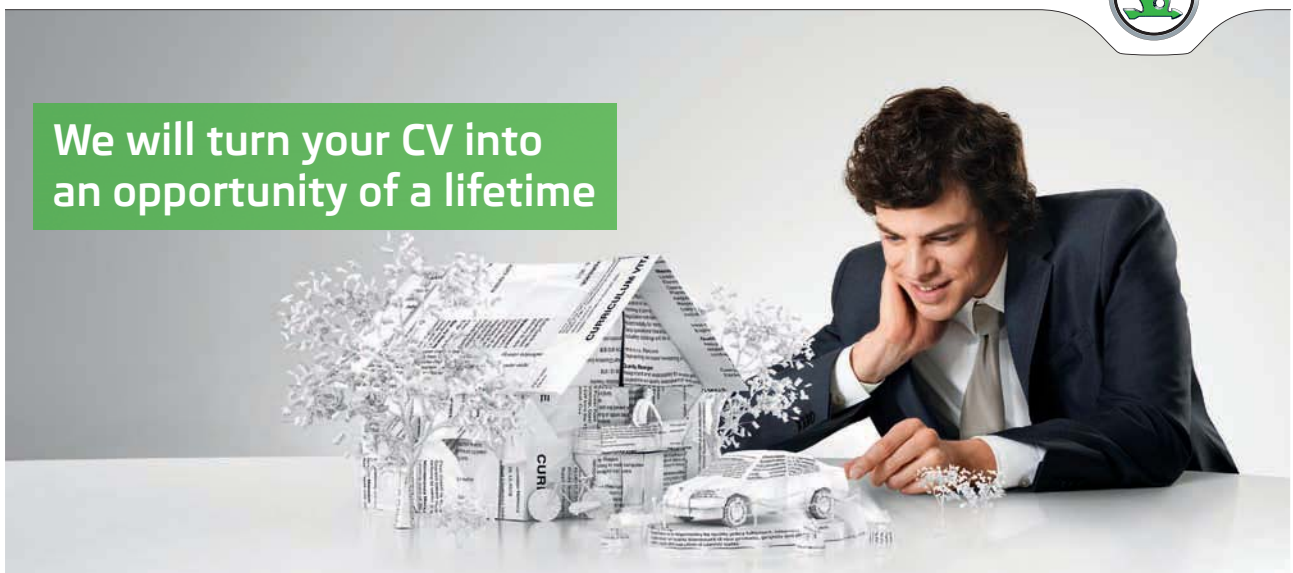
Interestingly, this formula was derived using essentially this method by British physicist Sir Joseph J. Thomson (1856–1940) in (Thomson 1904, page 58) at a time when it was still thought EM waves propagated through a luminiferous aether! Thomson was actually explaining the production of “Röntgen rays” (what we now call X-rays) when “cathode rays” (energetic electrons) impinge on a metal target by a process we now describe as “bremsstrahlung” (meaning braking radiation). In that case the charges (electrons) initially had high velocities and were abruptly *decelerated* producing the EM radiation (X-rays). [Thomson, JJ, 1904 *Electricity and Matter*, page 58, Archibald Constable & Co., Westminster. Available at California Digital Library <http://archive.org/details/electricityandma00thomiaala>].

SIMPLY CLEVER

ŠKODA



We will turn your CV into  
an opportunity of a lifetime



Do you like cars? Would you like to be a part of a successful brand?  
We will appreciate and reward both your enthusiasm and talent.  
Send us your CV. You will be surprised where it can take you.

Send us your CV on  
[www.employerforlife.com](http://www.employerforlife.com)



Click on the ad to read more

## 5.2 Electric dipole radiation

Consider a charge  $q$  undergoing simple harmonic motion in the  $z$ -direction between  $z = -d$  and  $z = +d$ . Its electric dipole moment is

$$\mathbf{p}(t) = qd \cos(\omega t) \hat{\mathbf{z}} = p_0 \cos(\omega t) \hat{\mathbf{z}}. \quad (5.7)$$

The charge  $q$  experiences acceleration

$$\mathbf{a}(t) = -d\omega^2 \cos(\omega t) \hat{\mathbf{z}}, \quad (5.8)$$

$$\therefore q^2 [a(t)]^2 = (qd)^2 \omega^4 \cos^2(\omega t) = p_0^2 \omega^4 \cos^2(\omega t). \quad (5.9)$$

Using Larmor's formula (Eq. 5.6) we obtain the total instantaneous and time-averaged electric dipole radiation power

$$P(t) = \frac{p_0^2 \omega^4}{6\pi\epsilon_0 c^3} \cos^2(\omega t), \quad \langle P \rangle = \frac{p_0^2 \omega^4}{12\pi\epsilon_0 c^3}. \quad (5.10)$$

### 5.2.1 Dipole radiation pattern

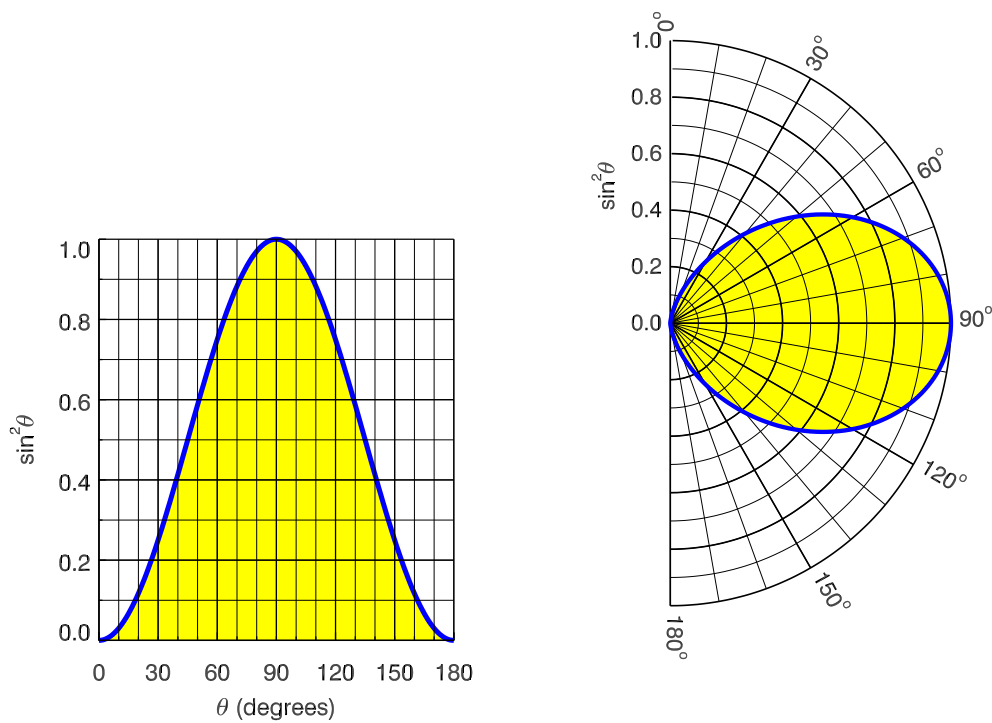
Using Eqs. 5.5 and 5.9, the time-averaged power emitted per unit solid angle is

$$\left\langle \frac{dP}{d\Omega} \right\rangle = \frac{p_0^2 \omega^4 \sin^2 \theta}{32\pi^2 \epsilon_0 c^3} = \frac{3}{8\pi} \langle P \rangle \sin^2 \theta. \quad (5.11)$$

To illustrate the shape of the dipole radiation pattern,  $\sin^2 \theta$  is plotted against  $\theta$  in Fig. 5.3(a). To better visualise the radiation pattern the same curve is plotted with polar coordinates in Fig. 5.3(b) where the vertical axis is the  $z$ -axis and corresponds to the direction of the oscillating dipole, i.e. charge is being accelerated in the  $\pm \hat{\mathbf{z}}$  direction.

Note that there is no radiation in the direction in which charge is accelerated, and the radiation power per unit solid angle is maximum in all directions perpendicular to the direction of acceleration. As there is no dependence on  $\phi$  there is azimuthal symmetry, and the dipole radiation pattern could be better visualised as a 3D surface traced out by rotating the curve in Fig. 5.3(b) around the  $z$ -axis.

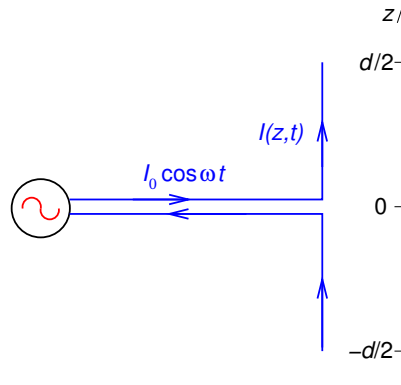




**Figure 5.3:** The power emitted per unit solid angle is proportional to  $\sin^2 \theta$  which is plotted against  $\theta$  in (a) with standard cartesian axes, and (b) polar axes.

### 5.2.2 Short centre-fed antennas

If an AC source  $I(t) = I_0 \cos \omega t$  is connected to a short (i.e. total length  $d \ll \lambda$ ) centre-fed dipole antenna (Fig. 5.4) it becomes an oscillating physical electric dipole, and so will radiate electromagnetic waves at frequency  $\nu = \omega/2\pi$ . The current will be maximum at the centre ( $z = 0$ ) of the antenna, and zero at its ends ( $z = \pm d/2$ ) because it has nowhere to go. If the antenna is short then the current will decrease linearly between the centre and the two ends, and the charge in each arm will be uniformly distributed along its length.



**Figure 5.4:** Short centre-fed dipole antenna.

The charges in the upper and lower arms are given by

$$Q_{\text{up}}(t) = \int I_0 \cos(\omega t) dt = \frac{I_0}{\omega} \sin(\omega t); \quad Q_{\text{low}}(t) = -Q_{\text{up}}(t), \quad (5.12)$$

so that the line charge density on the upper and lower arms is  $+\frac{2I_0}{\omega d} \sin(\omega t)$  and  $-\frac{2I_0}{\omega d} \sin(\omega t)$ , respectively, such that the dipole moment is

**About e-Learning for Kids** Established in 2004, e-Learning for Kids is a global nonprofit foundation dedicated to fun and free learning on the Internet for children ages 5 - 12 with courses in math, science, language arts, computers, health and environmental skills. Since 2005, more than 15 million children in over 190 countries have benefitted from eLessons provided by EFK! An all-volunteer staff consists of education and e-learning experts and business professionals from around the world committed to making difference. eLearning for Kids is actively seeking funding, volunteers, sponsors and courseware developers; get involved! For more information, please visit [www.e-learningforkids.org](http://www.e-learningforkids.org).

- The number 1 MOOC for Primary Education
- Free Digital Learning for Children 5-12
- 15 Million Children Reached



$$\mathbf{p}(t) = p_0 \sin(\omega t) \hat{\mathbf{z}}, \quad p_0 = \frac{d I_0}{2 \omega}. \quad (5.13)$$

The total time-averaged radiation power is

$$\langle P \rangle = \frac{d^2 \langle I^2 \rangle \omega^2}{24 \pi \epsilon_0 c^3} = \langle I^2 \rangle R_{\text{rad}} \quad (5.14)$$

where  $\langle I^2 \rangle = I_0^2/2$  and, by analogy with resistance  $R$  where  $I^2 R$  gives the power dissipated as heat,

$$R_{\text{rad}} = \frac{d^2 \omega^2}{24 \pi \epsilon_0 c^3} \approx 197 \left( \frac{d}{\lambda} \right)^2 \quad (\Omega) \quad (5.15)$$

is the “radiation resistance” of the antenna ( $\lambda$  is wavelength) such that  $\langle I^2 \rangle R_{\text{rad}}$  gives the power radiated in EM waves.

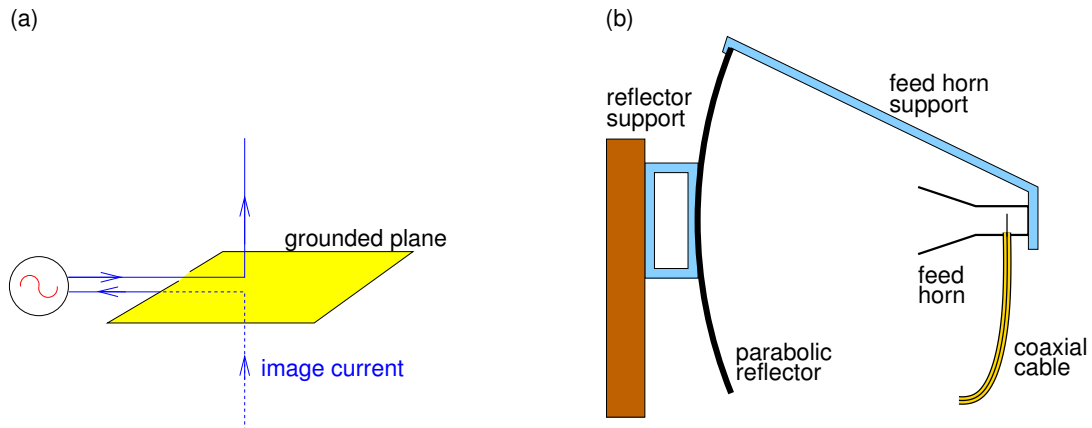
### 5.2.3 Half-wave antennas

The half-wave antenna, i.e. full length  $d = \lambda/2$ , has the advantage of having nearly zero reactance, and so is an efficient radiator, as well as having a radiation pattern which closely resembles the  $\sin^2 \theta$  dipole radiation pattern. It also has a radiation resistance of  $R_{\text{rad}} = 73 \Omega$  which matches well the  $75 \Omega$  impedance of coaxial cable commonly used in radio-frequency (RF) applications. We shall discuss long antennas in more detail at the end of this chapter.

A related type of antenna, which is effectively a dipole antenna, is the ground-plane vertical monopole antenna (Fig. 5.5a). It comprises a single vertical conductor insulated from the ground plane. The signal is connected between the base of the vertical and the ground plane near the base. The electric field of a charge placed above a grounded plane is identical (above the plane) to that of the charge plus a negative image charge at the mirror-image point below the plane. In a similar way, the ground-plane vertical monopole antenna acts like a dipole antenna. Usually a  $\lambda/4$  ground-plane vertical antenna is used as it is equivalent to a  $\lambda/2$  dipole antenna, at half the cost! The ground-plane need not necessarily be literally the ground. In fact the earth is far from being a perfect conductor and is often supplemented by laying a conducting surface such as wire netting on the ground. Car antennas are often  $\lambda/4$  ground-plane vertical monopole

antennas, with the “ground plane” being the car roof.

To transmit or receive at microwave (GHz) frequencies, a  $\lambda/4$  ground-plane vertical monopole antenna is placed inside a microwave feed-horn located at the focus of a parabolic “dish”, and pointing to “illuminate” the dish (Fig. 5.5b). Such an arrangement with an appropriate “back-end” (receiver/transmitter and amplifiers) can be used to transmit and/or receive microwave signals. It is also the basic design of a radio telescope.



**Figure 5.5:** (a) Vertical ground-plane monopole antenna. (b) Microwave feed horn (at focus of parabolic reflector) with a  $\lambda/4$  ground-plane vertical monopole antenna fed by a coaxial cable. (Not to scale.)

### 5.3 Scattering of EM radiation

We can understand scattering of electromagnetic radiation in terms of acceleration of charges by the electric field of an EM wave, or by the electric field of an EM wave inducing an oscillating electric dipole in a particle, conductor or dielectric, in either case resulting in scattered (re-radiated) EM radiation. The strength of the scattering is determined by the total scattering cross section  $\sigma$  ( $\text{m}^2$ ). The angular distribution of scattered photons is determined by the differential cross section  $d\sigma/d\Omega$  ( $\text{m}^2 \text{sr}^{-1}$ ).

### 5.3.1 Scattering of EM radiation by free electrons

In the presence of a monochromatic plane wave  $\mathbf{E} = \mathbf{E}_0 \cos(\mathbf{k} \cdot \mathbf{r} - \omega t)$ , an electron located at  $\mathbf{r} = 0$  experiences electric field  $\mathbf{E} = \mathbf{E}_0 \cos(\omega t)$  and acceleration

$$\mathbf{a}(t) = \frac{-e\mathbf{E}(t)}{m_e} = -\frac{e}{m_e}\mathbf{E}_0 \cos(\omega t), \quad \langle a^2 \rangle = \frac{e^2 E_0^2}{2m_e^2}. \quad (5.16)$$

As the electron oscillates at the frequency of the incident radiation, the scattered radiation will have the same frequency. Using Larmor's formula we see that the electron emits radiation with time-averaged power

$$\langle P \rangle = \frac{e^4 E_0^2}{12\pi m_e^2 \epsilon_0 c^3} \quad (\text{W}). \quad (5.17)$$

The power radiated by the electron is taken from the energy flux of the incident monochromatic plane wave  $\mathbf{E} = \mathbf{E}_0 \cos(\mathbf{k} \cdot \mathbf{r} - \omega t)$ , which at  $\mathbf{r} = 0$  is

**Cynthia | AXA Graduate**

**AXA Global Graduate Program**

Find out more and apply

redefining / standards AXA

$$S = \varepsilon_0 E_0^2 c \cos^2(\omega t), \quad \langle S \rangle = \frac{\varepsilon_0 E_0^2}{2} c \quad (\text{W m}^{-2}). \quad (5.18)$$

It is almost as if the electron absorbed all the radiation hitting area equal to  $\langle P \rangle / \langle S \rangle$  and re-radiated it with power  $\langle P \rangle$ . This area is called the *Thomson cross section* after J.J. Thomson

$$\sigma_T = \frac{\langle P \rangle}{\langle S \rangle} = \frac{e^4}{6\pi m_e^2 \varepsilon_0^2 c^3} = 6.65 \times 10^{-29} \quad (\text{m}^2) \quad (5.19)$$

and is the cross section for scattering of electromagnetic radiation by free electrons, and applies provided  $\hbar\omega \ll m_e c^2$ .

### 5.3.2 Scattering of EM radiation by molecules

A molecule acquires an electric dipole moment in the presence of an electric field  $\mathbf{p} = \alpha_m \mathbf{E}$ . For the case of a dilute gas the Clausius-Mossotti equation yields

$$\alpha_m = \frac{\varepsilon_0}{n_v} (\varepsilon_r - 1) = \frac{\varepsilon_0}{n_v} (n^2 - 1) \quad (5.20)$$

where  $n_v$  is the number density of molecules,  $\varepsilon_r$  the relative permittivity and  $n$  is the refractive index. In the presence of an oscillating electric field due to an incident monochromatic plane wave  $\mathbf{E}_0 \cos(\mathbf{k} \cdot \mathbf{r} - \omega t)$  the molecule becomes an oscillating dipole which radiates with time-averaged power

$$\langle P \rangle = \frac{p_0^2 \omega^4}{12\pi \varepsilon_0 c^3} = \left( \frac{\varepsilon_0}{n_v} \right)^2 \frac{(n^2 - 1)^2 E_0^2 \omega^4}{12\pi \varepsilon_0 c^3}. \quad (5.21)$$

Dividing  $\langle P \rangle$  by the time-averaged energy flux of the incident wave  $\langle S \rangle = \frac{1}{2} \varepsilon_0 E_0^2 c$ , we obtain the cross section

$$\sigma_{\text{mol}} = \frac{(n^2 - 1)^2}{6\pi n_v^2 c^4} \omega^4 = \frac{(n^2 - 1)^2}{6\pi n_v^2} \left( \frac{2\pi\nu}{c} \right)^4 = \frac{8\pi^3}{3} \frac{(n^2 - 1)^2}{n_v^2} \lambda^{-4}. \quad (5.22)$$

Note that short wavelength light (blue) is scattered much more strongly than longer wavelengths (red), and this explains why the sky is blue and sunrises and sunsets are red.

## 5.4 Formal treatment of radiation by charges and currents

So far I have discussed in a reasonable amount of detail the propagation of electromagnetic waves, but their generation has only been dealt with in an approximate fashion when we derived Larmor's formula in a heuristic manner. A more rigorous approach involves deriving and solving the wave equations for the potentials  $V(\mathbf{r}, t)$  and  $\mathbf{A}(\mathbf{r}, t)$  which include the charges  $\rho(\mathbf{r}, t)$  and currents  $\mathbf{J}(\mathbf{r}, t)$  which are their sources, i.e. the inhomogeneous wave equations for the potentials.

### 5.4.1 Inhomogeneous wave equations for the potentials

These equations are obtained from Maxwell's equations by substituting  $\mathbf{E} = -\nabla V - \partial\mathbf{A}/\partial t$  into Gauss' law

$$\nabla \cdot \left( -\nabla V - \frac{\partial \mathbf{A}}{\partial t} \right) = \frac{\rho}{\varepsilon_0}, \quad \therefore \nabla^2 V + \frac{\partial \nabla \cdot \mathbf{A}}{\partial t} = -\frac{\rho}{\varepsilon_0}, \quad (5.23)$$

and into the modified Ampere's law for  $\mathbf{B} = \nabla \times \mathbf{A}$

$$\nabla \times (\nabla \times \mathbf{A}) = \mu_0 \mathbf{J} + \mu_0 \varepsilon_0 \frac{\partial}{\partial t} \left( -\nabla V - \frac{\partial \mathbf{A}}{\partial t} \right), \quad (5.24)$$

$$\nabla(\nabla \cdot \mathbf{A}) - \nabla^2 \mathbf{A} = \mu_0 \mathbf{J} - \nabla \left( \mu_0 \varepsilon_0 \frac{\partial V}{\partial t} \right) - \mu_0 \varepsilon_0 \frac{\partial^2 \mathbf{A}}{\partial t^2}, \quad (5.25)$$

$$\therefore \nabla^2 \mathbf{A} - \mu_0 \varepsilon_0 \frac{\partial^2 \mathbf{A}}{\partial t^2} = -\mu_0 \mathbf{J} - \nabla \left( \nabla \cdot \mathbf{A} + \mu_0 \varepsilon_0 \frac{\partial V}{\partial t} \right). \quad (5.26)$$

Equations 5.23 and 5.26 can be written in a convenient form if we use the *Lorentz gauge*, i.e. if we set

$$\nabla \cdot \mathbf{A} = -\mu_0 \varepsilon_0 \frac{\partial V}{\partial t}. \quad (5.27)$$

Then, we get the inhomogeneous wave equations

$$\nabla^2 V - \mu_0 \varepsilon_0 \frac{\partial^2 V}{\partial t^2} = -\frac{\rho}{\varepsilon_0}, \quad (5.28)$$

$$\nabla^2 \mathbf{A} - \mu_0 \varepsilon_0 \frac{\partial^2 \mathbf{A}}{\partial t^2} = -\mu_0 \mathbf{J}. \quad (5.29)$$

### 5.4.2 Retarded potentials

Imagine there is a variable point charge  $q(t)$  at the origin. Strictly, this is not allowed by conservation of charge, but if it were we would expect the potential outside the source to be a spherical wave solution of the homogeneous wave equation for  $V$ . Since  $q$  is at the origin, the solutions would be of the form  $V(\mathbf{r}, t) = g(t+r/c)/r$  (incoming wave) and  $V(\mathbf{r}, t) = g(t-r/c)/r$  (outgoing wave), where  $g(x)$  is any differentiable function, as may be verified by substitution. For unbounded space only the outgoing wave is the physical solution. Comparing this solution with the potential of a point charge  $q$  at the origin, the solution of the inhomogeneous wave equation for  $V$  must be

$$V(\mathbf{r}, t) = \frac{q(t - r/c)}{4\pi\epsilon_0 r}. \quad (5.30)$$

This makes sense as it takes time  $r/c$  for information about changes in the value of  $q$  at the origin to reach radius  $r$ . We can immediately extend these ideas to obtain the solution to the inhomogeneous wave equations (Eqs. 5.29).

I joined MITAS because  
I wanted **real responsibility**

The Graduate Programme  
for Engineers and Geoscientists  
[www.discovermitas.com](http://www.discovermitas.com)



**Month 16**

I was a construction supervisor in the North Sea advising and helping foremen solve problems

Real work  
International opportunities  
Three work placements







For time dependent sources  $\rho(\mathbf{r}, t)$  and  $\mathbf{J}(\mathbf{r}, t)$  we need to take account of the time taken for information to propagate from the source points  $\mathbf{r}'$  to the field point  $\mathbf{r}$ , which in vacuum takes a time  $|\mathbf{r} - \mathbf{r}'|/c$ . This means that the fields at the field point at time  $t$  depend on the charge density and the current density at  $\mathbf{r}'$  at the *retarded time*  $t_{\text{ret}} \equiv t - |\mathbf{r} - \mathbf{r}'|/c$ . The solutions of the inhomogeneous wave equations, the so-called *retarded potentials*, are then

$$V(\mathbf{r}, t) = \frac{1}{4\pi\epsilon_0} \int \frac{\rho(\mathbf{r}', t - |\mathbf{r} - \mathbf{r}'|/c)}{|\mathbf{r} - \mathbf{r}'|} d^3r', \quad \mathbf{A}(\mathbf{r}, t) = \frac{\mu_0}{4\pi} \int \frac{\mathbf{J}(\mathbf{r}', t - |\mathbf{r} - \mathbf{r}'|/c)}{|\mathbf{r} - \mathbf{r}'|} d^3r'. \quad (5.31)$$

### 5.4.3 Sinusoidal time dependence

For sinusoidal time dependence of the sources

$$\rho(\mathbf{r}', t_{\text{ret}}) = \rho(\mathbf{r}') e^{-i\omega t_{\text{ret}}} = \rho(\mathbf{r}') e^{-i\omega(t - |\mathbf{r} - \mathbf{r}'|/c)} = \rho(\mathbf{r}') e^{ik|\mathbf{r} - \mathbf{r}'|} e^{-i\omega t}, \quad (5.32)$$

$$\mathbf{J}(\mathbf{r}', t_{\text{ret}}) = \mathbf{J}(\mathbf{r}') e^{ik|\mathbf{r} - \mathbf{r}'|} e^{-i\omega t}. \quad (5.33)$$

If we are only interested in the radiation fields we do not need  $V(\mathbf{r}, t)$  as we can obtain  $\mathbf{E}(\mathbf{r}, t)$  from  $\mathbf{B}(\mathbf{r}, t)$ , and  $\mathbf{B}(\mathbf{r}, t)$  from  $\mathbf{A}(\mathbf{r}, t)$ .

The vector potential for sinusoidal sources is

$$\mathbf{A}(\mathbf{r}, t) = \frac{\mu_0}{4\pi} \int \frac{\mathbf{J}(\mathbf{r}') e^{ik|\mathbf{r} - \mathbf{r}'|}}{|\mathbf{r} - \mathbf{r}'|} d^3r' e^{-i\omega t}. \quad (5.34)$$

Approximations may be made at both small and large different distances from the source, but at intermediate distances no approximations are possible.

In the *near zone* where  $k|\mathbf{r} - \mathbf{r}'| \ll 1$  we have the *quasi-static limit* where

$$\mathbf{A}(\mathbf{r}, t) \approx \frac{\mu_0}{4\pi} \int \frac{\mathbf{J}(\mathbf{r}')}{|\mathbf{r} - \mathbf{r}'|} d^3r' e^{-i\omega t}. \quad (5.35)$$

In the *far zone* or *radiation zone*, where  $r' \ll r$ , referring to Fig. 5.6 it is clear that the error is

negligible if we replace  $|\mathbf{r} - \mathbf{r}'|$  by  $(r - \hat{\mathbf{r}} \cdot \mathbf{r}')$ . Then

$$\mathbf{A}(\mathbf{r}, t) = \frac{\mu_0 e^{ikr}}{4\pi r} \int \mathbf{J}(\mathbf{r}') e^{-ik\hat{\mathbf{r}} \cdot \mathbf{r}'} d^3r' e^{-i\omega t}. \tag{5.36}$$

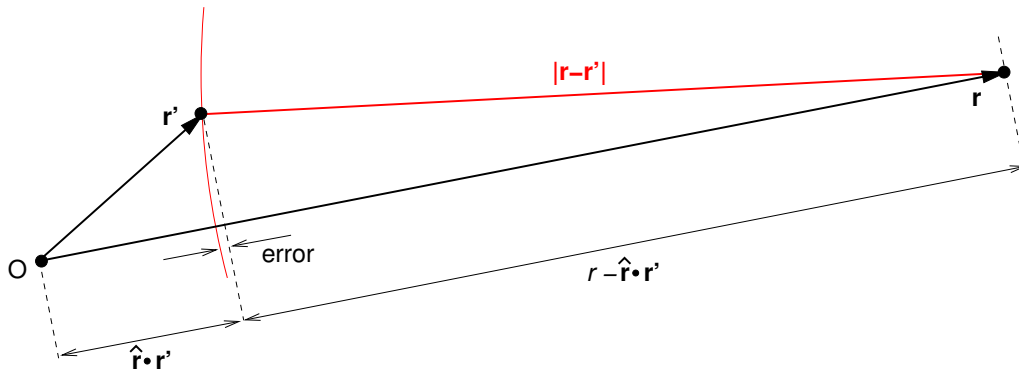


Figure 5.6: Justification of the approximation  $|\mathbf{r} - \mathbf{r}'| \approx (r - \hat{\mathbf{r}} \cdot \mathbf{r}')$  when  $r \gg r'$ .

### 5.5 Antenna theory and multipole expansion in the far zone

We can make a multipole expansion for  $e^{-ik\hat{\mathbf{r}} \cdot \mathbf{r}'}$  using a Taylor series expansion

$$e^{-ik\hat{\mathbf{r}} \cdot \mathbf{r}'} = \sum_{m=0}^{\infty} \frac{(-ik\hat{\mathbf{r}} \cdot \mathbf{r}')^m}{m!} = 1 - ik\hat{\mathbf{r}} \cdot \mathbf{r}' - \dots \tag{5.37}$$

The 1st term in the series corresponds to electric dipole radiation and the 2nd term corresponds to magnetic dipole radiation. Physical radiating systems for these two cases are the short centre-fed antenna and magnetic dipole antenna shown in Fig. 5.7.

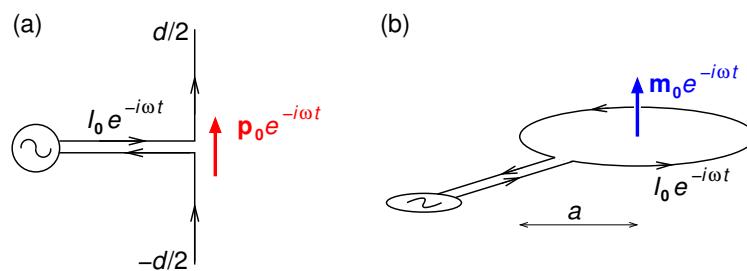


Figure 5.7: (a) A short centre-fed antenna has  $d \ll \lambda$ . (b) A magnetic dipole antenna.

### 5.5.1 Electric dipole radiation term

The vector potential for this term is

$$\mathbf{A}(\mathbf{r}, t) = \frac{\mu_0 e^{ikr}}{4\pi r} \int \mathbf{J}(\mathbf{r}') e^{-i\omega t} d^3r', \quad (5.38)$$

and if we knew the velocities of all the  $N$  individual charges making up the current we could replace the integral with a sum

$$\int \mathbf{J}(\mathbf{r}') e^{-i\omega t} d^3r' \longleftrightarrow \sum_{i=1}^N q_i \mathbf{v}_i = \sum_{i=1}^N q_i \frac{d\mathbf{r}_i}{dt} = \frac{d}{dt} \sum_{i=1}^N q_i \mathbf{r}_i = \frac{d\mathbf{p}}{dt} \quad (5.39)$$

where  $\mathbf{p}$  is the electric dipole moment. Now, we can write for the time dependence of the dipole moment  $\mathbf{p}(t) = p_0 e^{-i\omega t} \hat{\mathbf{z}}$  such that  $d\mathbf{p}/dt = -i\omega p_0 e^{-i\omega t} \hat{\mathbf{z}}$ , giving the vector potential for an oscillating electric dipole

**ie** business school

93%  
OF MIM STUDENTS ARE  
WORKING IN THEIR SECTOR 3 MONTHS  
FOLLOWING GRADUATION

**MASTER IN MANAGEMENT**

- STUDY IN THE CENTER OF MADRID AND TAKE ADVANTAGE OF THE UNIQUE OPPORTUNITIES THAT THE CAPITAL OF SPAIN OFFERS
- PROPEL YOUR EDUCATION BY EARNING A DOUBLE DEGREE THAT BEST SUITS YOUR PROFESSIONAL GOALS
- STUDY A SEMESTER ABROAD AND BECOME A GLOBAL CITIZEN WITH THE BEYOND BORDERS EXPERIENCE

Length: 10 MONTHS  
Av. Experience: 1 YEAR  
Language: ENGLISH / SPANISH  
Format: FULL-TIME  
Intakes: SEPT / FEB

**5 SPECIALIZATIONS**  
PERSONALIZE YOUR PROGRAM

**#10 WORLDWIDE**  
MASTER IN MANAGEMENT  
FINANCIAL TIMES

**55 NATIONALITIES**  
IN CLASS

[www.ie.edu/master-management](http://www.ie.edu/master-management) | [mim.admissions@ie.edu](mailto:mim.admissions@ie.edu) | [f](#) [t](#) [i](#) Follow us on IE MIM Experience

$$\mathbf{A}(\mathbf{r}, t) = -i \frac{\mu_0 \omega}{4\pi} p_0 \frac{e^{i(kr - \omega t)}}{r} \hat{\mathbf{z}} \quad (5.40)$$

$$= -i \frac{\mu_0 \omega}{4\pi} p_0 \frac{e^{i(kr - \omega t)}}{r} (\cos \theta \hat{\mathbf{r}} - \sin \theta \hat{\boldsymbol{\theta}}). \quad (5.41)$$

The magnetic field is  $\nabla \times \mathbf{A}$  and for periodic radiation fields  $\nabla \times \rightarrow i\mathbf{k} \times$  where, for the spherical wave,  $\mathbf{k} = k \hat{\mathbf{r}}$ . Then

$$\mathbf{B}(\mathbf{r}, t) = -i \frac{\mu_0 \omega}{4\pi} p_0 \frac{e^{i(kr - \omega t)}}{r} ik \hat{\mathbf{r}} \times (\cos \theta \hat{\mathbf{r}} - \sin \theta \hat{\boldsymbol{\theta}}), \quad (5.42)$$

$$\therefore \mathbf{B}(\mathbf{r}, t) = -\frac{\mu_0 k \omega}{4\pi} p_0 \frac{e^{i(kr - \omega t)}}{r} \sin \theta \hat{\boldsymbol{\phi}}. \quad (5.43)$$

$$\therefore \mathbf{H}(\mathbf{r}, t) = -\frac{k \omega}{4\pi} p_0 \frac{e^{i(kr - \omega t)}}{r} \sin \theta \hat{\boldsymbol{\phi}}. \quad (5.44)$$

We can obtain the electric field from Ampere's law for a current free region,  $\nabla \times \mathbf{B} = \mu_0 \varepsilon_0 (\partial \mathbf{E} / \partial t)$ , which is equivalent to  $i\mathbf{k} \times \mathbf{B} = -i\omega \mu_0 \varepsilon_0 \mathbf{E}$  for periodic radiation fields. Hence,

$$\mathbf{E}(\mathbf{r}, t) = \left( \frac{-k}{\omega \mu_0 \varepsilon_0} \right) \left( -\frac{\mu_0 k \omega}{4\pi} \right) p_0 \frac{e^{i(kr - \omega t)}}{r} \sin \theta \hat{\mathbf{r}} \times \hat{\boldsymbol{\phi}}, \quad (5.45)$$

$$= -\left( \frac{k^2}{4\pi \varepsilon_0} \right) p_0 \frac{e^{i(kr - \omega t)}}{r} \sin \theta \hat{\boldsymbol{\theta}}. \quad (5.46)$$

Thus, for an electric dipole antenna as shown in Fig. 5.7(a) with the antenna oriented in the  $\hat{\mathbf{z}}$  (vertical) direction the radiation will be polarised with  $\mathbf{E}$  in the  $\hat{\boldsymbol{\theta}}$  direction, i.e. vertical if viewed from a horizontal plane containing the antenna.

The Poynting vector is  $\mathbf{S} = \text{Re}\{\mathbf{E}\} \times \text{Re}\{\mathbf{H}\}$

$$\mathbf{S}(\mathbf{r}, t) = \left( \frac{k^3 \omega}{4\pi \varepsilon_0} \right) p_0^2 \frac{\cos^2(kr - \omega t)}{4\pi r^2} \sin^2 \theta \hat{\mathbf{r}}, \quad (5.47)$$

$$= \frac{\omega^4 p_0^2}{16\pi \varepsilon_0 c^3 r^2} \cos^2(kr - \omega t) \sin^2 \theta \hat{\mathbf{r}}. \quad (5.48)$$

The time-averaged power radiated per unit solid angle is  $r^2\langle S \rangle$ , so that

$$\left\langle \frac{dP}{d\Omega} \right\rangle = \frac{\omega^4 p_0^2}{32\pi\epsilon_0 c^3} \sin^2 \theta \quad (5.49)$$

in agreement with the result in Eq. 5.11 obtained from a heuristic treatment.

## 5.5.2 Magnetic dipole radiation term

A real example of an oscillating magnetic dipole is the magnetic dipole antenna which is sketched in Fig. 5.7(b). The magnetic dipole term in the expansion for the vector potential is

$$\mathbf{A}(\mathbf{r}, t) = -ik \frac{\mu_0 e^{ikr}}{4\pi r} \int (\hat{\mathbf{r}} \cdot \mathbf{r}') \mathbf{J}(\mathbf{r}') e^{-i\omega t} d^3 r', \quad (5.50)$$

and in Section 5.6 of “Essential Electromagnetism” I showed that

$$\int \mathbf{J}(\mathbf{r}') \mathbf{r} \cdot \mathbf{r}' d^3 r = \mathbf{m} \times \mathbf{r} \quad (5.51)$$

where

$$\mathbf{m} = \frac{1}{2} \int \mathbf{r}' \times \mathbf{J}(\mathbf{r}') d^3 r' \quad (5.52)$$

is the magnetic dipole moment. Hence, setting  $\mathbf{m} = m_0 \hat{\mathbf{z}} = m_0 (\cos \theta \hat{\mathbf{r}} - \sin \theta \hat{\boldsymbol{\theta}})$  the vector potential of an oscillating magnetic dipole moment is

$$\mathbf{A}(\mathbf{r}, t) = ik \frac{\mu_0 e^{ikr}}{4\pi r} \hat{\mathbf{r}} \times (m_0 \cos \theta \hat{\mathbf{r}} - m_0 \sin \theta \hat{\boldsymbol{\theta}}) e^{-i\omega t} \quad (5.53)$$

$$= -ik \frac{\mu_0 m_0 \sin \theta}{4\pi r} e^{ikr - i\omega t} \hat{\boldsymbol{\phi}}. \quad (5.54)$$

The magnetic field is  $\nabla \times \mathbf{A} = i\mathbf{k} \times \mathbf{A}$  for periodic radiation fields, where  $\mathbf{k} = k \hat{\mathbf{r}}$ , i.e.

$$\mathbf{B}(\mathbf{r}, t) = i(k \hat{\mathbf{r}}) \times \mathbf{A}(\mathbf{r}, t) = -k^2 \frac{\mu_0 m_0 \sin \theta}{4\pi r} e^{ikr - i\omega t} \hat{\boldsymbol{\theta}}. \quad (5.55)$$

As we did for electric dipole radiation, we can obtain the electric field from Ampere’s law which,

for periodic radiation fields, is equivalent to  $\mathbf{E} = -\mathbf{k} \times \mathbf{B}/\omega\mu_0\epsilon_0$ . Hence, the electric field is

$$\mathbf{E}(\mathbf{r}, t) = \frac{k}{\omega\mu_0\epsilon_0} \hat{\mathbf{r}} \times \mathbf{B}(\mathbf{r}, t), \quad (5.56)$$

$$= \frac{k^3}{\omega\mu_0\epsilon_0} \frac{\mu_0 m_0 \sin\theta}{4\pi r} e^{ikr-i\omega t} \hat{\phi}, \quad (5.57)$$

$$= \frac{k^2}{c\epsilon_0} \frac{m_0 \sin\theta}{4\pi r} e^{ikr-i\omega t} \hat{\phi}. \quad (5.58)$$

Thus, for a magnetic dipole antenna as shown in Fig. 5.7(b) with the loop antenna located in the horizontal plane the radiation will be polarised with  $\mathbf{E}$  horizontal.

The Poynting vector is  $\mathbf{S} = \text{Re}\{\mathbf{E}\} \times \text{Re}\{\mathbf{H}\} = \text{Re}\{\mathbf{E}\} \times \text{Re}\{\mathbf{B}\}/\mu_0$

$$\mathbf{S}(\mathbf{r}, t) = \frac{\omega^4 \mu_0 m_0^2}{16\pi^2 c^3 r^2} \cos^2(kr - \omega t) \sin^2\theta \hat{\mathbf{r}}. \quad (5.59)$$

The time-averaged power radiated per unit solid angle is  $r^2\langle S \rangle$ , so that



"I studied English for 16 years but...  
...I finally learned to speak it in just six lessons"  
Jane, Chinese architect

ENGLISH OUT THERE

Click to hear me talking before and after my unique course download

$$\left\langle \frac{dP}{d\Omega} \right\rangle = \frac{\omega^4 \mu_0 m_0^2}{32\pi^2 c^3} \sin^2 \theta \quad (5.60)$$

which has the same form as for electric dipole radiation with the substitution of  $\mu_0 m_0$  for  $p_0/\varepsilon_0$ , and has the same  $\sin^2 \theta$  dipole radiation pattern. The total time-averaged power is

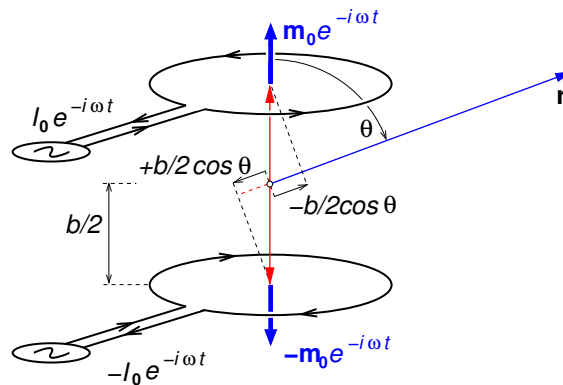
$$\langle P \rangle = \oint \frac{\omega^4 \mu_0 m_0^2 \sin^2 \alpha}{32\pi^2 c^3} \sin^2 \theta d\Omega, \quad (5.61)$$

$$= 2\pi \int_{-1}^1 \frac{\omega^4 \mu_0 m_0^2 \sin^2 \alpha}{32\pi^2 c^3} (1 - \cos^2 \theta) d \cos \theta, \quad (5.62)$$

$$= \frac{\mu_0 \omega^4 m_0^2}{12\pi c^3}. \quad (5.63)$$

## 5.6 Radiation from quadrupole antennas

Magnetic quadrupole radiation may be produced by a pair of oppositely directed magnetic dipole antennas, as sketched in Fig. 5.8. We may add the vector potentials of the two magnetic dipoles taking account of the angle-dependent phase shift for each dipole. Looking at the paths from the centres of the two AC current loops which comprise the radiating system, the wave generated by the upper dipole travels a distance shorter by  $b/2 \cos \theta$ , and the wave generated by the lower dipole travels a distance  $b/2 \cos \theta$  longer, compared to (fictitious) waves from midway between the centres of the current loops.



**Figure 5.8:** Far zone approximation applied to a physical magnetic quadrupole.

We can thus adapt the magnetic field of the magnetic dipole antenna (Eq. 5.55) to obtain the

magnetic field of a magnetic quadrupole

$$\mathbf{B}(\mathbf{r}, t) = -k^2 \frac{\mu_0 m_0 \sin \theta}{4\pi r} e^{ikr-i\omega t} \left( e^{-ikb \cos \theta/2} - e^{ikb \cos \theta/2} \right) \hat{\boldsymbol{\theta}}, \quad (5.64)$$

$$= -k^2 \frac{\mu_0 m_0 \sin \theta}{4\pi r} e^{ikr-i\omega t} 2i \sin(kb \cos \theta/2) \hat{\boldsymbol{\theta}}, \quad (5.65)$$

$$= -\frac{ik^2 \mu_0 m_0 e^{ikr-i\omega t}}{2\pi r} \sin \theta \sin(kb \cos \theta/2) \hat{\boldsymbol{\theta}}. \quad (5.66)$$

The electric field, Poynting vector and radiation pattern are then

$$\mathbf{E}(\mathbf{r}, t) = \frac{ik^2 m_0 e^{ikr-i\omega t}}{\varepsilon_0 c 2\pi r} \sin \theta \sin(kb \cos \theta/2) \hat{\boldsymbol{\phi}}, \quad (5.67)$$

$$\mathbf{S}(\mathbf{r}, t) = \frac{k^4 m_0^2 [-\sin^2(kr - \omega t)]}{\varepsilon_0 c 4\pi^2 r^2} \sin^2 \theta \sin^2(kb \cos \theta/2) \hat{\mathbf{r}}, \quad (5.68)$$

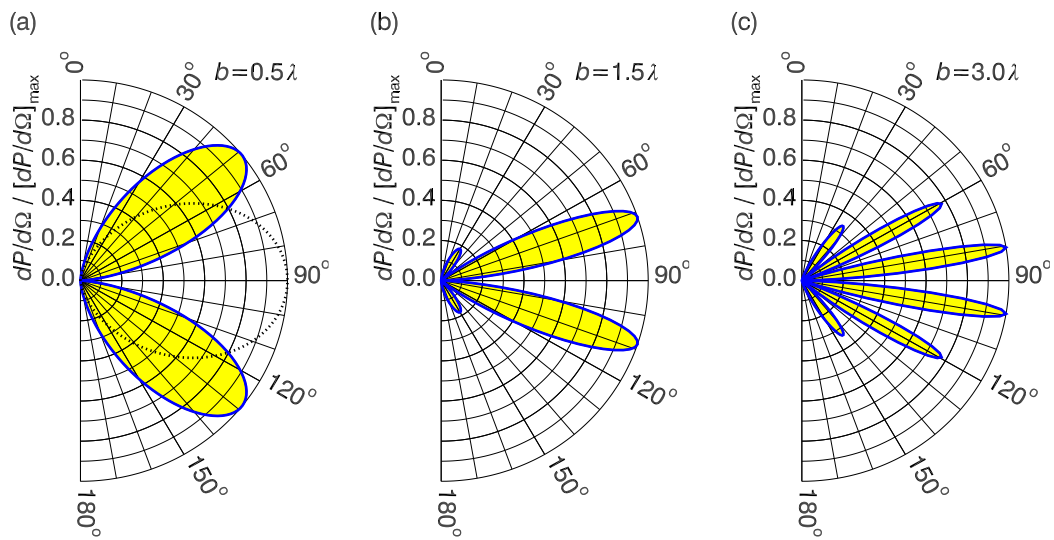
$$\left\langle \frac{dP}{d\Omega} \right\rangle = \frac{k^4 m_0^2}{\varepsilon_0 c 8\pi^2} \sin^2 \theta \sin^2(kb \cos \theta/2). \quad (5.69)$$

The radiation pattern for such an oscillating magnetic quadrupole is shown in Fig. 5.9 for three values of  $b$ . For  $b = \lambda/2$  we have the equivalent of a half-wave antenna and we see a fairly standard quadrupole radiation pattern having two lobes at  $50^\circ$  and  $130^\circ$ . For larger  $b$  values the radiation pattern becomes more complicated with the addition of “side-lobes”. Electric quadrupole radiation can be dealt with by similar methods, i.e. the superposition of a pair of oppositely pointing oscillating electric dipoles.

## 5.7 Radiation from long antennas

In Section 2.2 we discussed standing waves on open-circuited transmission lines (Fig. 2.7). Imagine pulling apart the final quarter-wavelength of the line and stretching the ends apart to become an antenna of length equal to half a wavelength, i.e. a “half-wave antenna” as in Fig. 5.10. The current distribution on each line will be essentially unchanged, and so there will be a standing sinusoidal wave on the antenna as shown. The only justification of this procedure is that for these current distributions on the antenna one can predict the radiation pattern which is in agreement with that observed.



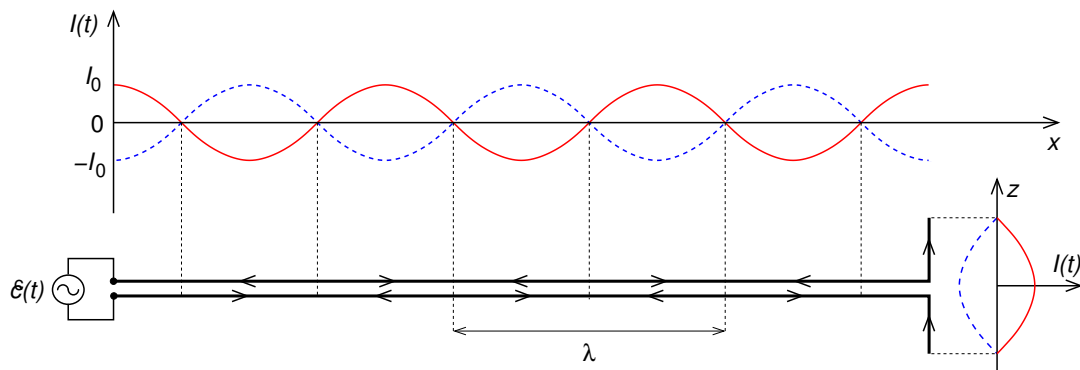


**Figure 5.9:** The radiation pattern of an oscillating magnetic quadrupole is shown for (a)  $b = \lambda/2$ , (b)  $b = 3\lambda/2$ , (c)  $b = 3\lambda$ . The dotted curve in part (a) gives a dipole radiation pattern.

For an antenna of arbitrary full-length  $d$  the current along the antenna is

$$I(z, t) = \begin{cases} I_0 \sin [k (d/2 + z)] e^{-i\omega t} & (-d/2 < z < 0) \\ I_0 \sin [k (d/2 - z)] e^{-i\omega t} & (0 < z < d/2) \end{cases} \quad (5.70)$$

where  $z$  is the distance along the antenna from its centre. We can use the far zone approximation



**Figure 5.10:** Transmission line modified to become a half-wave antenna.

(Eq. 5.36) to obtain the the vector potential,

$$\mathbf{A}(\mathbf{r}, t) = \frac{\mu_0 e^{ikr}}{4\pi r} \int_{-d/2}^{d/2} I(z', t) e^{-ikz' \cos \theta} dz', \tag{5.71}$$

$$\tag{5.72}$$

where we have used  $\hat{\mathbf{r}} \cdot \mathbf{r}' = z' \cos \theta$  (see Fig. 5.11).

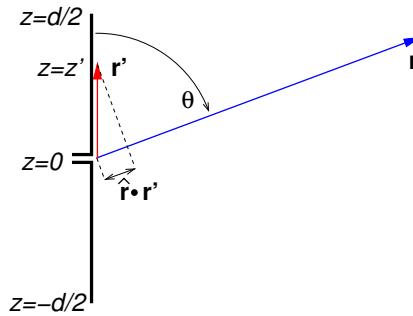


Figure 5.11: A centre-fed antenna.

Excellent Economics and Business programmes at:



university of groningen




“The perfect start of a successful, international career.”

**CLICK HERE**  
to discover why both socially and academically the University of Groningen is one of the best places for a student to be

[www.rug.nl/feb/education](http://www.rug.nl/feb/education)



Then,

$$\mathbf{A}(\mathbf{r}, t) = \hat{\mathbf{z}} \frac{\mu_0 I_0 e^{i(kr - \omega t)}}{4\pi r} \left\{ \int_{-d/2}^0 \sin [k(d/2 + z')] e^{-ikz' \cos \theta} dz' + \int_0^{d/2} \sin [k(d/2 - z')] e^{-ikz' \cos \theta} dz' \right\}, \quad (5.73)$$

$$= -\hat{\mathbf{z}} \frac{\mu_0 I_0 e^{i(kr - \omega t)}}{4\pi r} \left\{ \left[ e^{-ikz' \cos \theta} \left( \frac{\cos[k(d/2 + z')] + i \cos \theta \sin[k(d/2 + z')]}{k \sin^2 \theta} \right) \right]_{-d/2}^0 + \left[ e^{-ikz' \cos \theta} \left( \frac{-\cos[k(d/2 - z')] + i \cos \theta \sin[k(d/2 - z')]}{k \sin^2 \theta} \right) \right]_0^{d/2} \right\}, \quad (5.74)$$

$$= -(\hat{\mathbf{r}} \cos \theta - \hat{\boldsymbol{\theta}} \sin \theta) \frac{\mu_0 I_0 e^{i(kr - \omega t)}}{2\pi r} \frac{\cos(kd/2) - \cos(\cos \theta kd/2)}{k \sin^2 \theta}. \quad (5.75)$$

For radiation fields the magnetic field is  $i\mathbf{k} \times \mathbf{A}$  where, for the spherical wave,  $\mathbf{k} = k\hat{\mathbf{r}}$ . Then

$$\mathbf{B}(\mathbf{r}, t) = \sin \theta \hat{\boldsymbol{\phi}} \frac{\mu_0 I_0 e^{i(kr - \omega t)}}{2\pi r} \frac{\cos(kd/2) - \cos(\cos \theta kd/2)}{\sin^2 \theta}, \quad (5.76)$$

$$\mathbf{H}(\mathbf{r}, t) = \sin \theta \hat{\boldsymbol{\phi}} \frac{I_0 e^{i(kr - \omega t)}}{2\pi r} \frac{\cos(kd/2) - \cos(\cos \theta kd/2)}{\sin^2 \theta}, \quad (5.77)$$

and the electric field is  $\mathbf{E} = -\mathbf{k} \times \mathbf{B}/\omega\mu_0\epsilon_0$ , giving

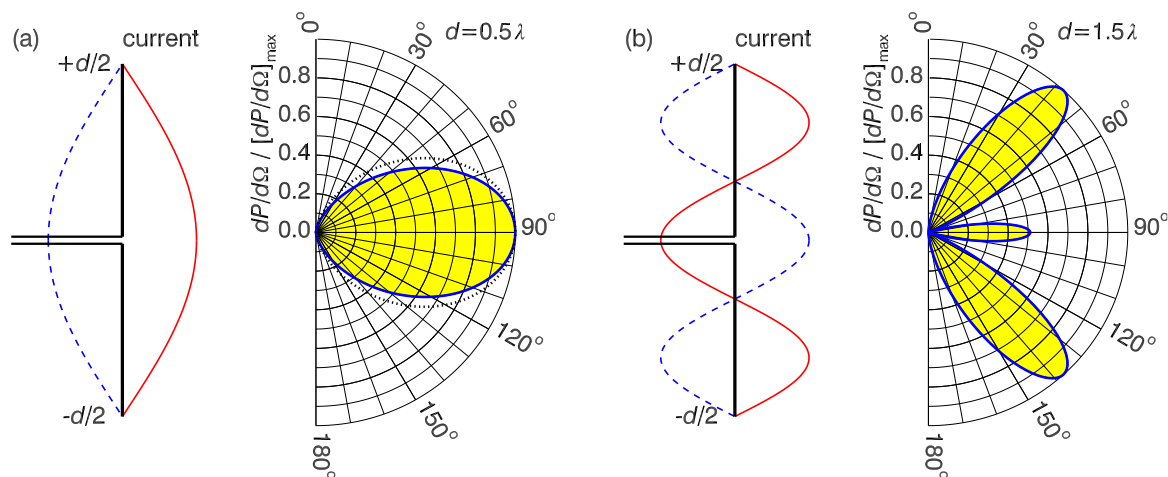
$$\mathbf{E}(\mathbf{r}, t) = k \sin \theta \hat{\boldsymbol{\theta}} \frac{I_0 e^{i(kr - \omega t)}}{2\pi\epsilon_0\omega r} \frac{\cos(kd/2) - \cos(\cos \theta kd/2)}{\sin^2 \theta}. \quad (5.78)$$

Finally the Poynting vector  $\mathbf{S} = \mathbf{E} \times \mathbf{H}$  and radiation pattern  $\langle dP/d\Omega \rangle = r^2 \langle |\mathbf{S}| \rangle$  are

$$\mathbf{S}(\mathbf{r}, t) = \frac{I_0^2 k \cos^2(kr - \omega t)}{4\pi^2 \epsilon_0 \omega r^2} \frac{[\cos(kd/2) - \cos(\cos \theta kd/2)]^2}{\sin^2 \theta} \hat{\mathbf{r}}, \quad (5.79)$$

$$\left\langle \frac{dP}{d\Omega} \right\rangle = \frac{\langle I^2 \rangle}{4\pi^2 \epsilon_0 c} \frac{[\cos(kd/2) - \cos(\cos \theta kd/2)]^2}{\sin^2 \theta}. \quad (5.80)$$

Current distributions and radiation patterns are given for standing-wave antennas for various lengths in Fig. 5.12. Of particular interest is the half-wave antenna shown in Fig. 5.12(a) whose radiation pattern can be approximated by that of an oscillating point electric dipole (dotted curve). As we move to longer dipoles (or shorter wavelengths) the antenna beam pattern becomes more complicated and no longer resembles a dipole pattern, having only a weak lobe at  $\theta = 0$  but having strong side-lobes.



**Figure 5.12:** Standing wave current distributions (left) and antenna radiation patterns (right) are shown for antennas of various lengths. The current distributions are shown at  $t = 0$  (red) and at half a period later  $t = T/2$  (blue dashed). The radiation patterns are normalised to the maximum values. (a)  $d = \lambda/2$  is the so-called half-wave antenna whose radiation pattern resembles the  $\sin^2 \theta$  dipole radiation pattern (dotted curve); (b)  $d = 3\lambda/2$ .

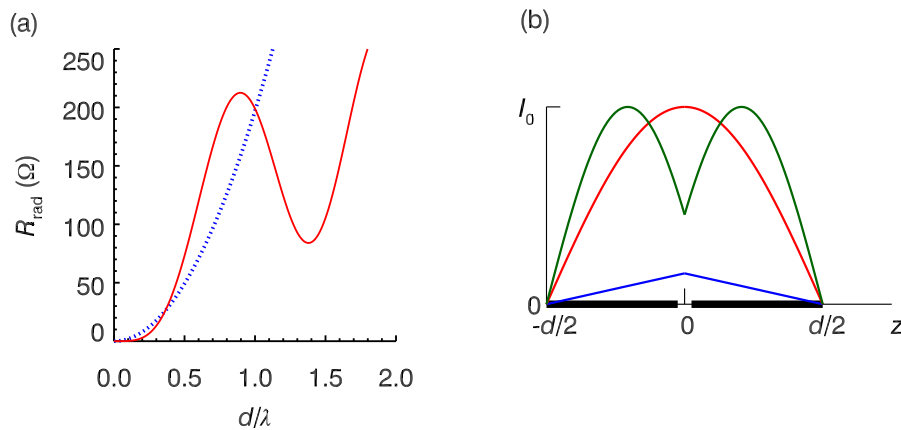
Integrating Eq. 5.80 over solid angle gives the time-averaged power

$$\langle P \rangle = \frac{\langle I^2 \rangle}{4\pi^2 \epsilon_0 c} 2\pi \int_{-1}^1 \frac{[\cos(kd/2) - \cos(\cos\theta kd/2)]^2}{1 - \cos^2 \theta} d(\cos \theta), \quad (5.81)$$

where we have used  $\langle \cos^2(kr - \omega t) \rangle = 1/2$  and  $\langle [I(t)]^2 \rangle = I_0^2/2$ . This is in the form of Ohm's law which, for an AC current, is  $\langle P \rangle = \langle I^2 \rangle R$ , and so the radiation resistance of a long centre-fed antenna is

$$R_{\text{rad}} = \frac{1}{2\pi \epsilon_0 c} \int_{-1}^1 \frac{[\cos(kd/2) - \cos(\cos\theta kd/2)]^2}{1 - \cos^2 \theta} d(\cos \theta). \quad (5.82)$$

This is plotted in Fig. 5.13(b)–(c) as the solid red curves.



**Figure 5.13:** (a) Radiation resistance versus antenna length calculated using the formula for a long antenna (solid red curve, Eq. 5.82) and for the approximate formula for the short centre-fed antenna (dotted blue curve, Eq. 5.15); (b) Current distribution on a centre-fed antenna of length  $d = 0.05\lambda$  (blue),  $d = 0.5\lambda$  (red) and  $d = 0.85\lambda$  (green).

The radiation resistance of a short centre-fed dipole antenna (Eq. 5.15) has been added to

## American online

# LIGS University

is currently enrolling in the  
Interactive Online **BBA, MBA, MSc,**  
**DBA and PhD** programs:

- ▶ enroll **by September 30th, 2014** and
- ▶ **save up to 16%** on the tuition!
- ▶ pay in 10 installments / 2 years
- ▶ Interactive **Online** education
- ▶ visit [www.ligsuniversity.com](http://www.ligsuniversity.com) to find out more!

Note: LIGS University is not accredited by any nationally recognized accrediting agency listed by the US Secretary of Education. More info [here](#).



Fig. 5.13a) as the dotted blue curves, and is very different to that calculated using Eq. 5.82 (red curves). The reason for this is in the use of a different definition of the current appearing in Ohm's law. For the case of a short center-fed antenna the maximum current  $I_{\max}$  is much less than  $I_0$  which is the peak of the assumed sinusoidal standing wave — compare the peak current  $I_{\max} \ll I_0$  for  $d = 0.05\lambda$  with the peak currents  $I_{\max} = I_0$  for  $d = 0.5\lambda$  and  $d = 0.85\lambda$  shown in Fig. 5.13(b).

The antenna design will depend on the application, but to maximise the power radiated its impedance  $Z = R + iX$  should ideally be purely resistive, i.e. the reactance  $X$  should be negligible. The reactance  $X = \omega L - 1/\omega C$  of an antenna depends on its dimensions and the frequency, and is generally capacitive for short antennas and inductive for long antennas. In the case where the reactance is non-zero the antenna can be made to radiate more inefficiently by using impedance-matching techniques. Antenna design is an important topic in its own right and contains many subtleties which we cannot go into in this book — here I have only skimmed the surface.

## Summary of important concepts and equations

### An accelerated charge radiates: Larmor's formula

- Instantaneous power

$$\frac{dP}{d\Omega} = \frac{a^2 q^2 \sin^2 \theta}{(4\pi)^2 \epsilon_0 c^3}; \quad P = \oint \frac{dP}{d\Omega} d\Omega = \frac{a^2 q^2}{6\pi \epsilon_0 c^3}.$$

- Time-averaged electric dipole radiation by oscillating dipole  $\mathbf{p}(t) = p_0 \cos(\omega t) \hat{\mathbf{z}}$

$$\langle P \rangle = \frac{p_0^2 \omega^4}{12\pi \epsilon_0 c^3}; \quad \left\langle \frac{dP}{d\Omega} \right\rangle = \frac{p_0^2 \omega^4 \sin^2 \theta}{32\pi^2 \epsilon_0 c^3} = \frac{3}{8\pi} \langle P \rangle \sin^2 \theta.$$

- Dipole radiation pattern has  $\langle dP/d\Omega \rangle \propto \sin^2 \theta$ .
- A short centre-fed dipole antenna (total length  $d \ll \lambda$ ) fed with current  $I = I_0 \cos(\omega t)$  has dipole moment

$$\mathbf{p}(t) = \frac{d I_0}{2 \omega} \sin(\omega t) \hat{\mathbf{z}}. \quad (5.83)$$

- For a short centre-fed dipole antenna resistance is

$$\langle P \rangle = \frac{d^2 \langle I^2 \rangle \omega^2}{24\pi\epsilon_0 c^3} = \langle I^2 \rangle R_{\text{rad}}; \quad R_{\text{rad}} = \frac{d^2 \omega^2}{24\pi\epsilon_0 c^3} \approx 197 \left( \frac{d}{\lambda} \right)^2 (\Omega).$$

- Half-wave antennas with  $d = \lambda/2$  are more efficient radiators ( $R_{\text{rad}} = 73.13 \Omega$ ) and have radiation patterns almost identical to the standard dipole radiation pattern.

## Scattering

- EM waves incident on a particle (or small object) will produce oscillating charges or currents causing some of the incident radiation to be scattered (i.e. absorbed and re-radiated).
- The total cross section for scattering of EM waves is the time-averaged power re-radiated divided by the time-averaged incident energy flux.



**DON'T EAT YELLOW SNOW**

What will your advice be?

Some advice just states the obvious. But to give the kind of advice that's going to make a real difference to your clients you've got to listen critically, dig beneath the surface, challenge assumptions and be credible and confident enough to make suggestions right from day one. At Grant Thornton you've got to be ready to kick start a career right at the heart of business.

Sound like you? Here's our advice: visit [GrantThornton.ca/careers/students](http://GrantThornton.ca/careers/students)

Scan here to learn more about a career with Grant Thornton.



 **Grant Thornton**  
An instinct for growth™

© Grant Thornton LLP. A Canadian Member of Grant Thornton International Ltd

- For free electrons an EM wave causes acceleration  $-e\mathbf{E}(t)/m_e$  and re-radiation according to Larmor's formula.
- The classical formula for scattering by free electrons is the Thomson cross section

$$\sigma_T = \frac{\langle P \rangle}{\langle S \rangle} = \frac{e^4}{6\pi m_e^2 \varepsilon_0^2 c^3} = 6.65 \times 10^{-29} \text{ (m}^2\text{)}.$$

- For molecules, the EM wave induces an oscillating molecular dipole  $\alpha_m \mathbf{E}(t)$  so that the scattering cross section is

$$\sigma_{\text{mol}} = \frac{(n^2 - 1)^2}{6\pi n_v^2 c^4} \omega^4 = \frac{(n^2 - 1)^2}{6\pi n_v^2} \left( \frac{2\pi\nu}{c} \right)^4 = \frac{8\pi^3}{3} \frac{(n^2 - 1)^2}{n_v^2} \lambda^{-4}.$$

### Inhomogeneous wave equations for the potentials

$$\nabla^2 V - \mu_0 \varepsilon_0 \frac{\partial^2 V}{\partial t^2} = -\frac{\rho}{\varepsilon_0}, \quad \nabla^2 \mathbf{A} - \mu_0 \varepsilon_0 \frac{\partial^2 \mathbf{A}}{\partial t^2} = -\mu_0 \mathbf{J} \quad (5.84)$$

- Retarded potential solutions

$$V(\mathbf{r}, t) = \frac{1}{4\pi\varepsilon_0} \int \frac{\rho(\mathbf{r}', t - |\mathbf{r} - \mathbf{r}'|/c)}{|\mathbf{r} - \mathbf{r}'|} d^3r', \quad (5.85)$$

$$\mathbf{A}(\mathbf{r}, t) = \frac{\mu_0}{4\pi} \int \frac{\mathbf{J}(\mathbf{r}', t - |\mathbf{r} - \mathbf{r}'|/c)}{|\mathbf{r} - \mathbf{r}'|} d^3r'. \quad (5.86)$$

- The vector potential for sinusoidal sources is

$$\mathbf{A}(\mathbf{r}, t) = \frac{\mu_0}{4\pi} \int \frac{\mathbf{J}(\mathbf{r}') e^{ik|\mathbf{r}-\mathbf{r}'|}}{|\mathbf{r} - \mathbf{r}'|} d^3r' e^{-i\omega t}. \quad (5.87)$$

- In the far zone or radiation zone where  $r' \ll r$  we can replace  $|\mathbf{r} - \mathbf{r}'|$  by  $r - \hat{\mathbf{r}} \cdot \mathbf{r}'$

$$\mathbf{A}(\mathbf{r}, t) = \frac{\mu_0 e^{ikr}}{4\pi r} \int \mathbf{J}(\mathbf{r}') e^{-ik\hat{\mathbf{r}} \cdot \mathbf{r}'} d^3r' e^{-i\omega t}. \quad (5.88)$$



— For a long antenna along the  $z$  axis

$$\mathbf{A}(\mathbf{r}, t) = \frac{\mu_0 I_0 e^{ikr}}{4\pi r} \int I(z') e^{-ikz' \cos \theta} dz' e^{-i\omega t}, \quad (5.89)$$

## Exercises on Chapter 5

5–1 A walkie-talkie has a short centre-fed dipole antenna 12 cm long and radiates 3 W at 450 MHz. Assume the antenna has been balanced by a suitable inductor such that its impedance is purely resistive, and that the transmission line from the transceiver is matched to the impedance of the antenna.

- What is the radiation resistance of the antenna?
- What is the value of the peak current in the antenna?
- What is the peak electric field at the location of a receiving antenna at distance  $r$ ?
- With the transmitting walkie-talkie held vertically, an identical receiving walkie-talkie also held vertically at a distance of 2 km away can barely receive the transmission, i.e. the range is 2 km. What would be the range if: (i) the transmitting antenna were tilted at  $60^\circ$  towards the receiving antenna, (ii) the transmitting antenna was vertical but the receiving antenna was tilted at  $60^\circ$  towards the transmitting antenna, (iii) the transmitting antenna was vertical but the receiving antenna was tilted at  $60^\circ$  to the vertical in a plane perpendicular to the line of sight to the transmitting walkie-talkie?

5–2 Starting with the Clausius-Mossotti formula and the time-averaged dipole radiation power

$$\alpha_m = \frac{\varepsilon_0}{n_v} (\varepsilon_r - 1), \quad \langle P \rangle = \frac{p_0^2 \omega^4}{12\pi \varepsilon_0 c^3}, \quad (5.90)$$

find the cross section for scattering of light at  $\lambda_{500} \times 500$  nm wavelength by air molecules, and its associated mean free path  $1/(n_v \sigma)$ . Dry air at STP has  $\rho = 1.30 \text{ kg m}^{-3}$ , and  $n = 1.00029$ , and its molecular weight is 29.

5–3 In the presence of an applied uniform electric field  $\mathbf{E} = E_0 \hat{\mathbf{z}}$  the radial component of the electric field outside a perfectly-conducting sphere of radius  $a$  centred at the origin becomes

$$E_r(r, \theta, \phi) = E_0 \left( 1 + 2 \frac{a^3}{r^3} \right) \cos \theta. \quad (5.91)$$

Find the cross section for scattering of monochromatic EM waves by a perfectly-conducting sphere of radius: (a)  $a \ll \lambda$ , and (b)  $a \gg \lambda$ . Assume electric dipole radiation is responsible.

- 5-4 In the presence of an applied uniform magnetic field  $\mathbf{B} = B_0 \hat{\mathbf{z}}$  a perfectly-conducting sphere (radius  $a$ ) acquires a magnetic dipole moment  $\mathbf{m}_0$ .
- (a) What are the boundary conditions at the surface of the sphere? Find the magnetic dipole moment that, together with the applied magnetic field, satisfies the boundary conditions.
- (b) Find the contribution of magnetic dipole radiation to the cross section for scattering of monochromatic EM waves by a perfectly-conducting sphere of radius  $a \ll \lambda$ .
- 5-5 In bremsstrahlung an energetic electron is accelerated in the electric field of an atomic nucleus and emits electromagnetic radiation. Consider the case of an electron of kinetic energy 10 keV travelling on a trajectory parallel to the  $z$ -axis, and that there is a lead (Pb) nucleus located at impact parameter  $b = 10^{-10}$  m (distance of closest approach to the initial trajectory). Assume that for this impact parameter the electron's deflection is small, and that a calculation of the energy lost to electromagnetic radiation can be done classically.
- (a) By comparing  $b$  with the de Broglie wavelength  $h/mv$ , reassure yourself that a classical calculation is valid for this impact parameter and velocity.

.....Alcatel-Lucent 

[www.alcatel-lucent.com/careers](http://www.alcatel-lucent.com/careers)

What if you could build your future and create the future?

One generation's transformation is the next's status quo. In the near future, people may soon think it's strange that devices ever had to be "plugged in." To obtain that status, there needs to be "The Shift".



(b) By checking whether or not the deflection angle is small, reassure yourself that approximating the trajectory by a straight-line is valid.

(c) Estimate the total energy radiated by the electron. [Neglect atomic electrons.]

5–6 A pulsar is a rapidly-spinning magnetised neutron star observed at radio and sometimes higher (optical, X-ray and gamma-ray) frequencies. Neutron stars have masses of typically  $M \sim 1.4 M_{\odot}$  (solar mass  $1 M_{\odot} \approx 2 \times 10^{30}$  kg), radius  $R \approx 10$  km, moment of inertia  $I_{MoI} = \frac{2}{5}MR^2 \approx 10^{38}$  kg m<sup>2</sup> and a wide range of surface magnetic fields. Outside the neutron star the magnetic field may be approximated by that of a magnetic dipole at its centre making angle  $\alpha$  to the spin axis. Pulsars typically emit one or more narrow pulses at the same time into each spin period  $P$ , and measurements at different epochs generally show that the spin is slowing down as characterised by the time-derivative of the period  $\dot{P}$ .

(a) Derive formulae in terms of  $P$  and  $\dot{P}$  for the rotational kinetic energy  $E_{\text{rot}}$ , the rate of loss of rotational kinetic energy  $\dot{E}_{\text{rot}}$ , the pulsar's characteristic age  $\tau = E_{\text{rot}}/\dot{E}_{\text{rot}}$  and, assuming the slow-down is due to conversion of rotational kinetic energy to magnetic dipole radiation, the pulsar's minimum equatorial surface magnetic field  $B_{\text{min}}$ .

(b) The radio pulsar PSR J0157+6212 has  $P = 2.355$  s and  $\dot{P} = 1.89 \times 10^{-13}$  (“The Australia Telescope National Facility Pulsar Catalogue”, Manchester, R.N., et al., 2005, *Astron. J.*, 129, 1993, and <http://www.atnf.csiro.au/research/pulsar/psrcat/>). Find  $E_{\text{rot}}$ ,  $\dot{E}_{\text{rot}}$ ,  $\tau = E_{\text{rot}}/\dot{E}_{\text{rot}}$  and  $B_{\text{min}}$ .

## Bibliography

Due to limited space available in this series, it is not possible to go into the material in great depth, so I have attempted to encapsulate what I consider to be the essentials of electrodynamics and magnetism. In a separate volume “Essential Electromagnetism” I cover in similar depth electrostatics and magnetostatics. Both books contain student exercises, and the solutions to these are given in separate volumes:

- Protheroe, RJ 2013, *Essential Electromagnetism*, Ventus Publishing ApS, Copenhagen
- Protheroe, RJ 2013, *Essential Electromagnetism - Solutions*, Ventus Publishing ApS, Copenhagen
- Protheroe, RJ 2013, *Essential Electrodynamics - Solutions*, Ventus Publishing ApS, Copenhagen

The present book does not aim to replace existing textbooks in these subjects of which there are many excellent examples.

I would recommend in particular

- Barger, VD & Olsson MG 1987, *Classical electricity and magnetism: a contemporary perspective*, Allyn and Bacon, Boston
- Bleaney, BI & Bleaney, B 1957, *Electricity and magnetism*, Oxford, Clarendon
- Feynman, RP, Leighton, RB & Sands M 1963 *Feynman lectures on physics*, Volume 2, Addison-Wesley, Reading, Mass.
- Griffiths, DJ 1981, *Introduction to electrodynamics*, 3rd Edn. Prentice Hall, New Jersey.
- Heald, MA & J. B. Marion, JB 1994, *Classical electromagnetic radiation*, 3rd edn. Brooks/Cole, Pacific Grove CA
- Jackson, JD 1998, *Classical electrodynamics*, 3rd edn. Wiley, New York
- Lorrain, P, Corson, DR & Lorrain, F 1988, *Electromagnetic fields and waves: including electric circuits*, 3rd edn. Freeman, New York

- Nayfeh, MH & Brussel, MK 1985, *Electricity and magnetism*, Wiley, New York
- Purcell EM 1965, *Electricity and magnetism*, McGraw-Hill, New York

The following are useful for physical optics and antenna theory

- Hecht, E 2002, *Optics*, 4th edn. Addison-Wesley, San Francisco.
- Pedrotti, FL, Pedrotti, LM & Pedrotti, LS 2007, *Introduction to optics*, 3rd edn. Pearson, Upper Saddle River, N.J.
- Wolf. AE 1988, *Antenna Analysis*, Artech House, Inc., Norwood, MA, USA

The following are useful online resource of physical and chemical data, and mathematics, online integration, etc.

- Kaye, GWC & Laby, TH 1995, *Tables of physical & chemical constants*, 16th Edn. Kaye & Laby Online [www.kayelaby.npl.co.uk](http://www.kayelaby.npl.co.uk)
- *WolframAlpha computational knowledge engine*, <http://www.wolframalpha.com/>



**Maastricht University** *Leading in Learning!*

**Join the best at  
the Maastricht University  
School of Business and  
Economics!**

#### Top master's programmes

- 33<sup>rd</sup> place Financial Times worldwide ranking: MSc International Business
- 1<sup>st</sup> place: MSc International Business
- 1<sup>st</sup> place: MSc Financial Economics
- 2<sup>nd</sup> place: MSc Management of Learning
- 2<sup>nd</sup> place: MSc Economics
- 2<sup>nd</sup> place: MSc Econometrics and Operations Research
- 2<sup>nd</sup> place: MSc Global Supply Chain Management and Change

Sources: Keuzegids Master ranking 2013; Elsevier 'Beste Studies' ranking 2012; Financial Times Global Masters in Management ranking 2012

**Maastricht University is the best specialist university in the Netherlands**  
(Elsevier)

**Visit us and find out why we are the best!**  
**Master's Open Day: 22 February 2014**

[www.mastersopenday.nl](http://www.mastersopenday.nl)



## Appendices

### A SI units and dimensions

The SI base units are: the metre (m) which is the unit of length, the kilogram (kg) which is the unit of mass, the amp (A) which is the unit of electrical current, the second (s) which is the unit of time, the kelvin (K) which is the unit of thermodynamic temperature, the mole (mol) which is the unit of the amount of substance, the candela (cd) which is the unit of luminous intensity.

In any derivation it is important to check that the dimensions are the same on both sides of an equation. For this we will need the dimensions of electromagnetic quantities in terms of mass, distance, time and amps, or equivalently the units in terms of the SI base units.

The units and dimensions of the major electromagnetic quantities are tabulated below. [See e.g. NIST Special Publication 330, <http://www.nist.gov/pml/pubs/index.cfm>.]

Quantity	Symbol	Unit	Dimensions
work	$W$	joule (J)	$\text{m}^2 \text{kg s}^{-2}$
power	$P$	watt (W)	$\text{m}^2 \text{kg s}^{-3}$
electric charge	$q$	coulomb (C)	$\text{s A}$
electrostatic potential	$V$	volt (V)	$\text{m}^2 \text{kg s}^{-3} \text{A}^{-1}$
electric field	$\mathbf{E}$	volt per metre ( $\text{V m}^{-1}$ )	$\text{m kg s}^{-3} \text{A}^{-1}$
electric displacement	$\mathbf{D}$	coulomb per square metre ( $\text{C m}^{-2}$ )	$\text{m}^{-2} \text{s A}$
electrical resistance	$R$	ohm ( $\Omega$ )	$\text{m}^2 \text{kg s}^{-3} \text{A}^{-2}$
capacitance	$C$	farad (F)	$\text{m}^{-2} \text{kg}^{-1} \text{s}^4 \text{A}^2$
permittivity	$\epsilon$	farad per metre ( $\text{F m}^{-1}$ )	$\text{m}^{-3} \text{kg}^{-1} \text{s}^4 \text{A}^2$
magnetic field	$\mathbf{B}$	tesla (T)	$\text{kg s}^{-2} \text{A}^{-1}$
magnetic intensity	$\mathbf{H}$	amp-metre (A m)	$\text{m A}$
magnetic flux	$\Phi_B$	weber (Wb)	$\text{m}^2 \text{kg s}^{-2} \text{A}^{-1}$
inductance	$L$	henry (H)	$\text{m}^2 \text{kg s}^{-2} \text{A}^{-2}$
permeability	$\mu$	henrys per metre ( $\text{H m}^{-1}$ )	$\text{m kg s}^{-2} \text{A}^{-2}$

## B Derivation of the Maxwell stress tensor

Momentum conservation in electrodynamics is discussed in Section 1.4. Here we derive the formula for the Maxwell stress tensor, i.e.  $T_{ij}$  in Eq. 1.54, which must therefore satisfy

$$\begin{aligned} \sum_i \hat{\mathbf{e}}_i \int_V \left( \sum_j \frac{\partial}{\partial x_j} T_{ij} \right) d^3r \\ = \int_V \left\{ \varepsilon_0 [(\nabla \cdot \mathbf{E})\mathbf{E} - \mathbf{E} \times (\nabla \times \mathbf{E})] + \frac{1}{\mu_0} [(\nabla \cdot \mathbf{B})\mathbf{B} - \mathbf{B} \times (\nabla \times \mathbf{B})] \right\} d^3r. \end{aligned} \quad (\text{B.1})$$

Using index notation with the Einstein summation convention,

$$[(\nabla \cdot \mathbf{E})\mathbf{E} - \mathbf{E} \times (\nabla \times \mathbf{E})]_i = E_i \nabla_j E_j - \varepsilon_{ijk} E_j \varepsilon_{klm} \nabla_l E_m \quad (\text{B.2})$$

$$= E_i \nabla_j E_j - \varepsilon_{kij} \varepsilon_{klm} E_j \nabla_l E_m \quad (\text{B.3})$$

$$= E_i \nabla_j E_j - (\delta_{il} \delta_{jm} - \delta_{im} \delta_{jl}) E_j \nabla_l E_m \quad (\text{B.4})$$

$$= E_i \nabla_j E_j - (E_m \nabla_i E_m - E_l \nabla_l E_i) \quad (\text{B.5})$$

$$= E_i \nabla_j E_j + E_j \nabla_j E_i - \frac{1}{2} \nabla_i E_m E_m \quad (\text{B.6})$$

$$\therefore [(\nabla \cdot \mathbf{E})\mathbf{E} - \mathbf{E} \times (\nabla \times \mathbf{E})]_i = \nabla_j E_i E_j - \frac{1}{2} \nabla_j \delta_{ij} \mathbf{E} \cdot \mathbf{E}. \quad (\text{B.7})$$

$$\text{Similarly, } [(\nabla \cdot \mathbf{B})\mathbf{B} - \mathbf{B} \times (\nabla \times \mathbf{B})]_i = \nabla_j B_i B_j - \frac{1}{2} \nabla_j \delta_{ij} \mathbf{B} \cdot \mathbf{B}, \quad (\text{B.8})$$

and so

$$\begin{aligned} \varepsilon_0 [(\nabla \cdot \mathbf{E})\mathbf{E} - \mathbf{E} \times (\nabla \times \mathbf{E})] + \frac{1}{\mu_0} [(\nabla \cdot \mathbf{B})\mathbf{B} - \mathbf{B} \times (\nabla \times \mathbf{B})] \\ = \sum_i \hat{\mathbf{e}}_i \nabla_j \varepsilon_0 \left[ E_i E_j + c^2 B_i B_j - \frac{1}{2} \delta_{ij} (\mathbf{E} \cdot \mathbf{E} + c^2 \mathbf{B} \cdot \mathbf{B}) \right], \end{aligned} \quad (\text{B.9})$$

$$= \sum_i \hat{\mathbf{e}}_i \sum_j \frac{\partial}{\partial x_j} \varepsilon_0 \left[ E_i E_j + c^2 B_i B_j - \frac{1}{2} \delta_{ij} (\mathbf{E} \cdot \mathbf{E} + c^2 \mathbf{B} \cdot \mathbf{B}) \right]. \quad (\text{B.10})$$

Hence,

$$T_{ij} = \varepsilon_0 \left[ E_i E_j + c^2 B_i B_j - \frac{1}{2} \delta_{ij} (\mathbf{E} \cdot \mathbf{E} + c^2 \mathbf{B} \cdot \mathbf{B}) \right]. \quad (\text{B.11})$$

## C Time-derivative, divergence and curl of the fields of a monochromatic EM plane wave

Derived here for  $\mathbf{E}_0 e^{i(\mathbf{k}\cdot\mathbf{r}-\omega t)}$  using index notation; results for  $\mathbf{B}_0 e^{i(\mathbf{k}\cdot\mathbf{r}-\omega t)}$  have identical form.

$$\begin{aligned}
 \nabla \cdot \mathbf{E} &= \nabla_l \left[ \mathbf{E}_0 e^{i(\mathbf{k}\cdot\mathbf{r}-\omega t)} \right]_l \\
 &= \nabla_l \left[ E_{0,l} e^{i(\mathbf{k}\cdot\mathbf{r}-\omega t)} \right] \\
 &= E_{0,l} e^{i(\mathbf{k}\cdot\mathbf{r}-\omega t)} \nabla_l [i(\mathbf{k} \cdot \mathbf{r} - \omega t)] \\
 &= E_{0,l} e^{i(\mathbf{k}\cdot\mathbf{r}-\omega t)} \nabla_l [i(k_m r_m - \omega t)] \\
 &= ik_m E_{0,l} e^{i(\mathbf{k}\cdot\mathbf{r}-\omega t)} (\nabla_l r_m) \\
 &= ik_m E_{0,l} e^{i(\mathbf{k}\cdot\mathbf{r}-\omega t)} \delta_{lm} \\
 &= ik_m E_{0,m} e^{i(\mathbf{k}\cdot\mathbf{r}-\omega t)} \\
 &= i\mathbf{k} \cdot \mathbf{E}_0 e^{i(\mathbf{k}\cdot\mathbf{r}-\omega t)}
 \end{aligned}$$

$$\boxed{\therefore \nabla \cdot \mathbf{E} = i\mathbf{k} \cdot \mathbf{E}} \quad (\text{C.1})$$



**Empowering People. Improving Business.**

BI Norwegian Business School is one of Europe's largest business schools welcoming more than 20,000 students. Our programmes provide a stimulating and multi-cultural learning environment with an international outlook ultimately providing students with professional skills to meet the increasing needs of businesses.

BI offers four different two-year, full-time Master of Science (MSc) programmes that are taught entirely in English and have been designed to provide professional skills to meet the increasing need of businesses. The MSc programmes provide a stimulating and multi-cultural learning environment to give you the best platform to launch into your career.

- MSc in Business
- MSc in Financial Economics
- MSc in Strategic Marketing Management
- MSc in Leadership and Organisational Psychology

[www.bi.edu/master](http://www.bi.edu/master)

**BI NORWEGIAN BUSINESS SCHOOL**

EFMD **EQUIS** ACCREDITED



$$\begin{aligned}
[\nabla \times \mathbf{E}]_h &= \varepsilon_{hln} \nabla_l \left[ \mathbf{E}_0 e^{i(\mathbf{k} \cdot \mathbf{r} - \omega t)} \right]_n \\
&= \varepsilon_{hln} \nabla_l E_{0,n} e^{i(\mathbf{k} \cdot \mathbf{r} - \omega t)} \\
&= \varepsilon_{hln} E_{0,n} e^{i(\mathbf{k} \cdot \mathbf{r} - \omega t)} \nabla_l [i(\mathbf{k} \cdot \mathbf{r} - \omega t)] \\
&= \varepsilon_{hln} E_{0,n} e^{i(\mathbf{k} \cdot \mathbf{r} - \omega t)} \nabla_l [i(k_m r_m - \omega t)] \\
&= i k_m \varepsilon_{hln} E_{0,n} e^{i(\mathbf{k} \cdot \mathbf{r} - \omega t)} \nabla_l r_m \\
&= i k_m \varepsilon_{hln} E_{0,n} e^{i(\mathbf{k} \cdot \mathbf{r} - \omega t)} \delta_{lm} \\
&= i \varepsilon_{hln} k_l E_{0,n} e^{i(\mathbf{k} \cdot \mathbf{r} - \omega t)} \\
[\nabla \times \mathbf{E}]_h &= i \left\{ \mathbf{k} \times \left[ \mathbf{E}_0 e^{i(\mathbf{k} \cdot \mathbf{r} - \omega t)} \right] \right\}_h \\
\boxed{\therefore \nabla \times \mathbf{E} = i \mathbf{k} \times \mathbf{E}} & \tag{C.2}
\end{aligned}$$

$$\begin{aligned}
\frac{\partial}{\partial t} \mathbf{E} &= \frac{\partial}{\partial t} \mathbf{E}_0 e^{i(\mathbf{k} \cdot \mathbf{r} - \omega t)} \\
&= -i\omega \mathbf{E}_0 e^{i(\mathbf{k} \cdot \mathbf{r} - \omega t)} \\
\boxed{\therefore \frac{\partial}{\partial t} \mathbf{E} = -i\omega \mathbf{E}} & \tag{C.3}
\end{aligned}$$

## D EM field of a rectangular cross-section waveguide

Eqs. 4.15–4.18 are used to find  $\mathbf{E}(\mathbf{r}, t)$  and  $\mathbf{B}(\mathbf{r}, t)$  from  $B_z^0(x, y)$  (Eq. 4.36) for the TE modes, and from  $E_z^0(x, y)$  (Eq. 4.31) for the TM modes. The following formulae based on Eq. 4.38 will be useful

$$\omega_{mn} \equiv c\pi \sqrt{\left(\frac{m}{a}\right)^2 + \left(\frac{n}{b}\right)^2}, \quad k_{mn}(\omega) = \frac{1}{c} \sqrt{\omega^2 - \omega_{mn}^2}. \tag{D.1}$$

For the TE modes  $m$  or  $n$  or both must be non-zero:

$$E_x = \frac{\omega c^2}{\omega_{mn}^2} \frac{n\pi}{b} B_{mn} \cos\left(\frac{m\pi x}{a}\right) \sin\left(\frac{n\pi y}{b}\right) \sin(k_{mn}z - \omega t), \quad (\text{D.2})$$

$$E_y = -\frac{\omega c^2}{\omega_{mn}^2} \frac{m\pi}{a} B_{mn} \sin\left(\frac{m\pi x}{a}\right) \cos\left(\frac{n\pi y}{b}\right) \sin(k_{mn}z - \omega t), \quad (\text{D.3})$$

$$E_z = 0, \quad (\text{D.4})$$

$$B_x = \frac{k_{mn}(\omega) c^2}{\omega_{mn}^2} \frac{m\pi}{a} B_{mn} \sin\left(\frac{m\pi x}{a}\right) \cos\left(\frac{n\pi y}{b}\right) \sin(k_{mn}z - \omega t), \quad (\text{D.5})$$

$$B_y = \frac{k_{mn}(\omega) c^2}{\omega_{mn}^2} \frac{n\pi}{b} B_{mn} \cos\left(\frac{m\pi x}{a}\right) \sin\left(\frac{n\pi y}{b}\right) \sin(k_{mn}z - \omega t), \quad (\text{D.6})$$

$$B_z = B_{mn} \cos\left(\frac{m\pi x}{a}\right) \cos\left(\frac{n\pi y}{b}\right) \cos(k_{mn}z - \omega t). \quad (\text{D.7})$$

For the TM modes both  $m$  and  $n$  must be non-zero:

$$E_x = -\frac{k_{mn}(\omega) c^2}{\omega_{mn}^2} \frac{m\pi}{a} E_{mn} \cos\left(\frac{m\pi x}{a}\right) \sin\left(\frac{n\pi y}{b}\right) \sin(k_{mn}z - \omega t), \quad (\text{D.8})$$

$$E_y = \frac{k_{mn}(\omega) c^2}{\omega_{mn}^2} \frac{n\pi}{b} E_{mn} \sin\left(\frac{m\pi x}{a}\right) \cos\left(\frac{n\pi y}{b}\right) \sin(k_{mn}z - \omega t), \quad (\text{D.9})$$

$$E_z = E_{mn} \sin\left(\frac{m\pi x}{a}\right) \sin\left(\frac{n\pi y}{b}\right) \cos(k_{mn}z - \omega t), \quad (\text{D.10})$$

$$B_x = -\frac{\omega c^2}{\omega_{mn}^2} \frac{n\pi}{b} E_{mn} \cos\left(\frac{m\pi x}{a}\right) \sin\left(\frac{n\pi y}{b}\right) \sin(k_{mn}z - \omega t), \quad (\text{D.11})$$

$$B_y = \frac{\omega c^2}{\omega_{mn}^2} \frac{m\pi}{a} E_{mn} \sin\left(\frac{m\pi x}{a}\right) \cos\left(\frac{n\pi y}{b}\right) \sin(k_{mn}z - \omega t), \quad (\text{D.12})$$

$$B_z = 0. \quad (\text{D.13})$$

## E Summary of vector calculus identities

### E.1 Integral theorems

Gauss' theorem:

$$\int_S \nabla \times \mathbf{F} \cdot d\mathbf{S} = \oint_L \mathbf{F} \cdot d\mathbf{r} \quad (L \text{ bounds } S) \quad (\text{E.1})$$

Corollary to Gauss' Theorem:

$$\int_V \nabla \times \mathbf{F} \, d^3r = - \oint_S \mathbf{F} \times d\mathbf{S} \quad (S \text{ bounds } V) \quad (\text{E.2})$$

Stokes' theorem:

$$\int_V \nabla \cdot \mathbf{F} \, d^3r = \oint_S \mathbf{F} \cdot d\mathbf{S} \quad (S \text{ bounds } V) \quad (\text{E.3})$$

## Need help with your dissertation?

Get in-depth feedback & advice from experts in your topic area. Find out what you can do to improve the quality of your dissertation!

Get Help Now



Go to [www.helpmyassignment.co.uk](http://www.helpmyassignment.co.uk) for more info



## E.2 Product rules

$$\nabla(uv) = u(\nabla v) + v(\nabla u) \quad (\text{E.4})$$

$$\nabla(\mathbf{A} \cdot \mathbf{B}) = \mathbf{A} \times (\nabla \times \mathbf{B}) + \mathbf{B} \times (\nabla \times \mathbf{A}) + (\mathbf{A} \cdot \nabla)\mathbf{B} + (\mathbf{B} \cdot \nabla)\mathbf{A} \quad (\text{E.5})$$

$$\nabla \cdot (\mathbf{A} \times \mathbf{B}) = (\nabla \times \mathbf{A}) \cdot \mathbf{B} - (\nabla \times \mathbf{B}) \cdot \mathbf{A} \quad (\text{E.6})$$

$$\nabla \cdot (u\mathbf{A}) = (\nabla u) \cdot \mathbf{A} + u(\nabla \cdot \mathbf{A}) \quad (\text{E.7})$$

$$\nabla \times (u\mathbf{A}) = (\nabla u) \times \mathbf{A} + u(\nabla \times \mathbf{A}) \quad (\text{E.8})$$

$$\nabla \times (\mathbf{A} \times \mathbf{B}) = (\nabla \cdot \mathbf{B})\mathbf{A} - (\nabla \cdot \mathbf{A})\mathbf{B} + (\mathbf{B} \cdot \nabla)\mathbf{A} - (\mathbf{A} \cdot \nabla)\mathbf{B} \quad (\text{E.9})$$

## E.3 Second derivatives

$$\nabla \cdot (\nabla \psi) = \nabla^2 \psi \quad (\text{E.10})$$

$$\nabla \times (\nabla \psi) = 0 \quad (\text{E.11})$$

$$\nabla(\nabla \cdot \mathbf{A}) = \nabla \times (\nabla \times \mathbf{A}) + \nabla^2 \mathbf{A} \quad (\text{E.12})$$

$$\nabla \cdot (\nabla \times \mathbf{A}) = 0 \quad (\text{E.13})$$

$$\nabla \times (\nabla \times \mathbf{A}) = \nabla(\nabla \cdot \mathbf{A}) - \nabla^2 \mathbf{A} \quad (\text{E.14})$$

## E.4 Vector operations in cartesian coordinates

$$d\mathbf{r} = dx \hat{\mathbf{x}} + dy \hat{\mathbf{y}} + dz \hat{\mathbf{z}} \quad (\text{E.15})$$

$$d^3r = dx dy dz \quad (\text{E.16})$$

$$\nabla f = \frac{\partial f}{\partial x} \hat{\mathbf{x}} + \frac{\partial f}{\partial y} \hat{\mathbf{y}} + \frac{\partial f}{\partial z} \hat{\mathbf{z}} \quad (\text{E.17})$$

$$\nabla \cdot \mathbf{A} = \frac{\partial A_x}{\partial x} + \frac{\partial A_y}{\partial y} + \frac{\partial A_z}{\partial z} \quad (\text{E.18})$$

$$\nabla \times \mathbf{A} = \left( \frac{\partial A_z}{\partial y} - \frac{\partial A_y}{\partial z} \right) \hat{\mathbf{x}} + \left( \frac{\partial A_x}{\partial z} - \frac{\partial A_z}{\partial x} \right) \hat{\mathbf{y}} + \left( \frac{\partial A_y}{\partial x} - \frac{\partial A_x}{\partial y} \right) \hat{\mathbf{z}} \quad (\text{E.19})$$

$$\nabla^2 f = \frac{\partial^2 f}{\partial x^2} + \frac{\partial^2 f}{\partial y^2} + \frac{\partial^2 f}{\partial z^2} \quad (\text{E.20})$$

E.5 Vector operations in spherical polar coordinates  $(r, \theta, \phi)$ 

$$d\mathbf{r} = dr \hat{\mathbf{r}} + r d\theta \hat{\boldsymbol{\theta}} + r \sin \theta d\phi \hat{\boldsymbol{\phi}} \quad (\text{E.21})$$

$$d^3r = r^2 dr \sin \theta d\theta d\phi \quad (\text{E.22})$$

$$\nabla f = \frac{\partial f}{\partial r} \hat{\mathbf{r}} + \frac{1}{r} \frac{\partial f}{\partial \theta} \hat{\boldsymbol{\theta}} + \frac{1}{r \sin \theta} \frac{\partial f}{\partial \phi} \hat{\boldsymbol{\phi}} \quad (\text{E.23})$$

$$\nabla \cdot \mathbf{A} = \frac{1}{r^2} \frac{\partial}{\partial r} (r^2 A_r) + \frac{1}{r \sin \theta} \frac{\partial}{\partial \theta} (\sin \theta A_\theta) + \frac{1}{r \sin \theta} \frac{\partial A_\phi}{\partial \phi} \quad (\text{E.24})$$

$$\begin{aligned} \nabla \times \mathbf{A} = & \frac{1}{r \sin \theta} \left[ \frac{\partial}{\partial \theta} (\sin \theta A_\phi) - \frac{\partial A_\theta}{\partial \phi} \right] \hat{\mathbf{r}} + \frac{1}{r} \left[ \frac{1}{\sin \theta} \frac{\partial A_r}{\partial \phi} - \frac{\partial}{\partial r} (r A_\phi) \right] \hat{\boldsymbol{\theta}} \\ & + \frac{1}{r} \left[ \frac{\partial}{\partial r} (r A_\theta) - \frac{\partial A_r}{\partial \theta} \right] \hat{\boldsymbol{\phi}} \end{aligned} \quad (\text{E.25})$$

$$\nabla^2 f = \frac{1}{r^2} \frac{\partial}{\partial r} \left( r^2 \frac{\partial f}{\partial r} \right) + \frac{1}{r^2 \sin \theta} \frac{\partial}{\partial \theta} \left( \sin \theta \frac{\partial f}{\partial \theta} \right) + \frac{1}{r^2 \sin^2 \theta} \frac{\partial^2 f}{\partial \phi^2} \quad (\text{E.26})$$

E.6 Vector operations in cylindrical coordinates  $(\rho, \phi, z)$ 

$$d\mathbf{r} = d\rho \hat{\boldsymbol{\rho}} + \rho d\phi \hat{\boldsymbol{\phi}} + dz \hat{\mathbf{z}} \quad (\text{E.27})$$

$$d^3r = \rho d\rho d\phi dz \quad (\text{E.28})$$

$$\nabla f = \frac{\partial f}{\partial \rho} \hat{\boldsymbol{\rho}} + \frac{1}{\rho} \frac{\partial f}{\partial \phi} \hat{\boldsymbol{\phi}} + \frac{\partial f}{\partial z} \hat{\mathbf{z}} \quad (\text{E.29})$$

$$\nabla \cdot \mathbf{A} = \frac{1}{\rho} \frac{\partial}{\partial \rho} (\rho A_\rho) + \frac{1}{\rho} \frac{\partial A_\phi}{\partial \phi} + \frac{\partial A_z}{\partial z} \quad (\text{E.30})$$

$$\nabla \times \mathbf{A} = \left( \frac{1}{\rho} \frac{\partial A_z}{\partial \phi} - \frac{\partial A_\phi}{\partial z} \right) \hat{\boldsymbol{\rho}} + \left( \frac{\partial A_\rho}{\partial z} - \frac{\partial A_z}{\partial \rho} \right) \hat{\boldsymbol{\phi}} + \frac{1}{\rho} \left( \frac{\partial}{\partial \rho} (\rho A_\phi) - \frac{\partial A_\rho}{\partial \phi} \right) \hat{\mathbf{z}} \quad (\text{E.31})$$

$$\nabla^2 f = \frac{1}{\rho} \frac{\partial}{\partial \rho} \left( \rho \frac{\partial f}{\partial \rho} \right) + \frac{1}{\rho^2} \frac{\partial^2 f}{\partial \phi^2} + \frac{\partial^2 f}{\partial z^2} \quad (\text{E.32})$$

**Brain power**

By 2020, wind could provide one-tenth of our planet's electricity needs. Already today, SKF's innovative know-how is crucial to running a large proportion of the world's wind turbines.

Up to 25 % of the generating costs relate to maintenance. These can be reduced dramatically thanks to our systems for on-line condition monitoring and automatic lubrication. We help make it more economical to create cleaner, cheaper energy out of thin air.

By sharing our experience, expertise, and creativity, industries can boost performance beyond expectations. Therefore we need the best employees who can meet this challenge!

The Power of Knowledge Engineering

Plug into The Power of Knowledge Engineering.  
Visit us at [www.skf.com/knowledge](http://www.skf.com/knowledge)

**SKF**

## F Maxwell's Equations

Differential form:

<b>Vacuum:</b>	<b>Matter:</b>
$\nabla \cdot \mathbf{E} = \frac{\rho}{\varepsilon_0}$	$\nabla \cdot \mathbf{D} = \rho_f$ (Gauss' law)
$\nabla \cdot \mathbf{B} = 0$	$\nabla \cdot \mathbf{B} = 0$ (no magnetic charge)
$\nabla \times \mathbf{E} = -\frac{\partial \mathbf{B}}{\partial t}$	$\nabla \times \mathbf{E} = -\frac{\partial \mathbf{B}}{\partial t}$ (Faraday's law)
$\nabla \times \mathbf{B} = \mu_0 \mathbf{J} + \mu_0 \varepsilon_0 \frac{\partial \mathbf{E}}{\partial t}$	$\nabla \times \mathbf{H} = \mathbf{J}_f + \frac{\partial \mathbf{D}}{\partial t}$ (modified Ampère's law)

(F.1)

Integral form:

<b>Vacuum:</b>	<b>Matter:</b>
$\oint_S \mathbf{E} \cdot d\mathbf{S} = \frac{1}{\varepsilon_0} \int_V \rho d^3r$	$\oint_S \mathbf{D} \cdot d\mathbf{S} = \int_V \rho_f d^3r$
$\oint_S \mathbf{B} \cdot d\mathbf{S} = 0$	$\oint_S \mathbf{B} \cdot d\mathbf{S} = 0$
$\oint_L \mathbf{E} \cdot d\mathbf{r} = -\frac{d}{dt} \int_S \mathbf{B} \cdot d\mathbf{S}$	$\oint_L \mathbf{E} \cdot d\mathbf{r} = -\frac{d}{dt} \int_S \mathbf{B} \cdot d\mathbf{S}$
$\oint_L \mathbf{B} \cdot d\mathbf{r} = \mu_0 \int_S \mathbf{J} \cdot d\mathbf{S} + \mu_0 \varepsilon_0 \frac{d}{dt} \int_S \mathbf{E} \cdot d\mathbf{S}$	$\oint_L \mathbf{H} \cdot d\mathbf{r} = \int_S \mathbf{J}_f \cdot d\mathbf{S} + \frac{d}{dt} \int_S \mathbf{D} \cdot d\mathbf{S}$

(F.2)

Note: in the 1st row  $S$  bounds  $V$ ; in the 2nd row  $S$  is any closed surface; in the 3rd and 4th rows  $L$  bounds  $S$ .

## Index

- absorption, 83
- absorption coefficient, 86
- aether, luminiferous, 45
- Ampere's law, modified, 22
- Ampere's law, unmodified, 20
- amplitude reflection coefficient for parallel polarisation, 67
- amplitude reflection coefficient for perpendicular polarisation, 65
- amplitude transmission coefficient for parallel polarisation, 67
- amplitude transmission coefficient for perpendicular polarisation, 65
- angular frequency, 35
- anomalous dispersion, 92, 93
- antenna theory, 146
- antenna, ground-plane, 139
- antenna, half-wave, 139
- antenna, short centre-fed, 137
- antennas, long, 152
  
- boundary conditions at interface, 62
- Brewster's angle, 67
  
- cartesian coordinates, 173
- coaxial cable, 42, 116
- coherence, 50
- coherence area, 53
- coherence length, 50
- coherence time, 50
- coherence width, 51
- conductivity, dilute plasma, 99
- conductor, dispersion relation, 94
- conductor, refractive index, 94
- conductor, wave equation, 94
- continuity equation, 20
- cross section, Thomson, 142
  
- cut-off frequency, 102
- cylindrical coordinates, 174
  
- dilute plasmas, 97
- dilute plasmas, group velocity, 101
- dilute plasmas, phase velocity, 101
- dimensions, SI units, 166
- dipole radiation pattern, 136
- dispersion, 83, 89
- dispersion relation, 86
- dispersion relation, conductor, 94
- dispersion relation, dilute plasmas, 100
- dispersion relation, waveguide, 124
- dispersion, anomalous, 92
- dispersion, normal, 92
- dispersive media, 82
- displacement current, 21
- Doppler broadening, 52
  
- electric dipole radiation, 147
- electric field, induced, 14
- electro-motive force, 11
- electromagnetic waves, 44, 82
- electromagnetic waves, energy, 49
- electromagnetic waves, momentum, 49
- emf, motional, 12
- energy, 18
- energy in electromagnetic waves, 49
- energy, conservation, 23
- energy, magnetic field, 18
- evanescent wave, 73, 74
  
- far zone, 145
- Faraday rotation, 104
- Faraday's law, 13
- Faraday's law, vector potential form, 14
- Fourier transform, 89



- Fourier transform of gaussian, 91
- frequency, 35
- frequency, angular, 35
- frequency, cut-off, 102
- frequency, plasma, 100
- Fresnel equations, 61
- gaussian wave packet, 91
- grazing incidence, 72
- group velocity, 89, 91
- group velocity in dilute plasmas, 101
- group velocity, waveguide, 124
- induced electric field, 14
- inductance, 17
- inductance, mutual, 15
- inductor, 18
- inhomogeneous wave equations for the potentials, 143
- integral theorems, 171
- intensity, wave, 49
- Kirchhoff's circuit rules, 38
- Larmor's radiation formula, 132, 135
- laser, 53
- law of reflection, 59
- Lenz' law, 13
- line width, natural, 51
- Lorentz gauge, 143
- Lorentz oscillator model of dielectrics, 83
- Lorentzian function, 87
- lossless transmission line equations, 40
- lossless transmission line, standing waves, 43
- luminiferous aether, 45
- magnetic dipole radiation, 149
- magnetic quadrupole radiation, 151
- maser, 53
- Maxwell stress tensor, 26
- Maxwell stress tensor, derivation, 167
- Maxwell's equations, 20, 23, 175
- momentum density, 26
- momentum in electromagnetic waves, 49
- monochromatic plane wave solutions, 47
- monochromatic wave, 36
- motional emf, 12
- multipole expansion, vector potential, 146
- mutual inductance, 15
- natural line width, 51
- near zone, 145
- normal dispersion, 92
- one-dimensional wave equation, 34
- oscillator strengths, 88
- phase, 35
- phase constant, 35
- phase velocity, 37
- phase velocity in dilute plasmas, 101
- phase velocity, linear medium, 46
- phase velocity, lossless transmission line, 41
- phase velocity, waveguide, 124
- plane of incidence, 59
- plane wave, 36
- plasma frequency, 100
- plasmas, dilute , 97
- polarisation, 54
- polarisation, circular, 56
- polarisation, elliptical, 56
- polarisation, linear, 55
- Poynting vector, 25, 49
- Poynting vector, waveguide, 127
- Poynting's theorem, 24
- pressure broadening, 52
- pressure, radiation, 49
- product rules, 172
- pulsar, dispersion measure, 104

- pulsar, dispersion of pulses from, 103
- pulsar, rotation measure, 108
- quasi-monochromatic, 51
- quasi-static limit, 145
- radiation pressure, isotropic, 49
- radiation resistance, 139, 157
- radiation zone, 145
- radiation, electric dipole, 147
- radiation, magnetic dipole, 149
- radiation, magnetic quadrupole, 151
- rays, 37
- reflectance, 61
- reflectance of good conductors, 96
- refractive index, 58
- refractive index of conductor, 94
- retarded potentials, 145
- retarded time, 145
- rotation measure, 108
- scattering, 140
- scattering, by free electrons, 141
- scattering, by molecules, 142
- second derivatives, 172
- self-inductance, 17
- SI units and dimensions, 166
- skin depth, 95
- Snell's Law, 60
- speed of light, 46
- spherical coordinates, 173
- spherical waves, 37
- standing waves, lossless transmission line, 43
- TECU, 104
- telegraphers' equations, 40
- TEM wave, 115
- Thomson cross section, 142
- total electron content, vertical, 104
- total internal reflection, 68, 73
- transformer, 16
- transmission line, 38
- transmission line, characteristic impedance, 41
- transmission line, two-wire, 42
- transmittance, 61
- transverse electromagnetic wave, 115
- two-wire transmission line, 42
- units, SI, and dimensions, 166
- universal flux law, 13
- velocity, group, 89
- velocity, phase, 37
- visibility, 50
- VTEC, 104
- wave equation of conductor, 94
- wave equation, linear medium, 46
- wave equation, dilute plasma, 100
- wave equation, lossless transmission line, 41
- wave equation, one-dimensional, 34
- wave equation, vacuum, 46
- wave equations for the potentials, inhomogeneous, 143
- wave intensity, 49
- wave number, 35
- wave packet, 89
- wave packet, gaussian, 91
- wave propagation in dilute plasmas, 97
- wave vector, 37
- wave, complex form, 36
- wave, monochromatic, 36
- wave, monochromatic plane wave, 47
- wave, plane, 36
- wave, TEM, 115
- wave, transverse electromagnetic, 115
- waveguide modes, 119
- waveguide TE modes, 122
- waveguide TM modes, 121

waveguide, dispersion relation, 124  
waveguide, group velocity, 124  
waveguide, phase velocity, 124  
waveguide, Poynting vector, 127  
waveguide, TE wave, 116  
waveguide, TM wave, 116  
waveguide, transverse electric wave (TE), 116  
waveguide, transverse magnetic wave (TM), 116  
waveguides, 114  
wavelength, 34  
waves, electromagnetic, 44  
waves, spherical, 37

## TURN TO THE EXPERTS FOR **SUBSCRIPTION** CONSULTANCY

Subscribe is one of the leading companies in Europe when it comes to innovation and business development within subscription businesses.

We innovate new subscription business models or improve existing ones. We do business reviews of existing subscription businesses and we develop acquisition and retention strategies.

Learn more at [linkedin.com/company/subscribe](https://www.linkedin.com/company/subscribe) or contact Managing Director Morten Suhr Hansen at [mha@subscribe.dk](mailto:mha@subscribe.dk)

**SUBSCR**✓**BE** - *to the future*